

SN5650-PMOL-0125-

Oben hängender Schieber

Aerial cam unit

Arbeitsfläche	<i>Working area</i>	125 x 137 mm
Schieberbreite max.	<i>Cam unit width max.</i>	125 mm
Einbauhöhe	<i>Installation height</i>	275 mm
Schieberkraft	<i>Cam force</i>	> 276 kN

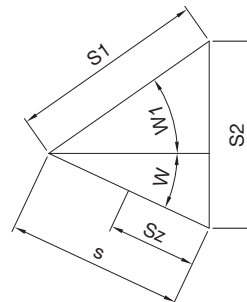
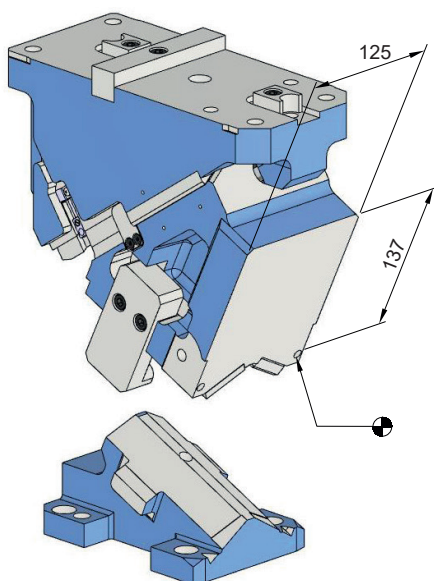
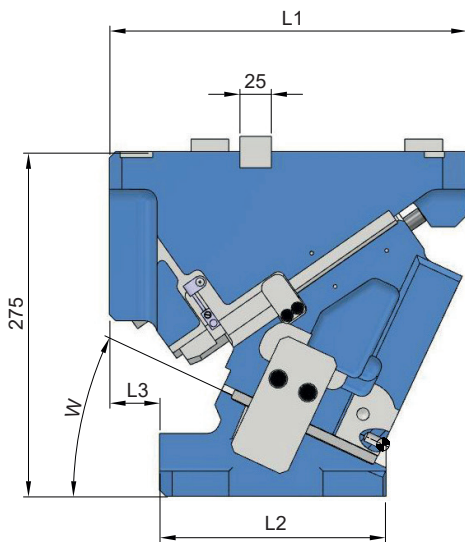

Gusstoleranzgrad CT
nach DIN ISO 8062

(blau = Rohgussfläche)

Casting tolerance grade CT
according to DIN ISO 8062

(blue = raw casting area)

**Positionskontrolle:
Control of position:**



Pos. 1

Schieber zusammengefahren
Cam is moved together



Pos. 2

Schieber ausgefahren
Cam is extended

Sz = Eingriffslänge Aktivrückzug

Sz = Engagement length of activ return

SN5650-PMOL-0125-

Oben hängender Schieber

Aerial cam unit

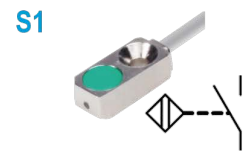
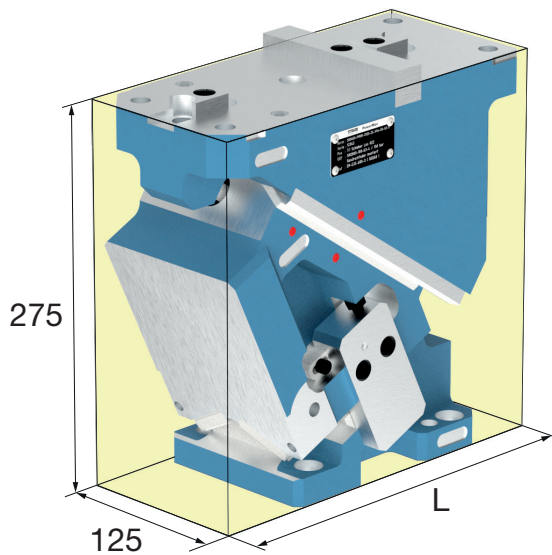

Mat.: EN-GJS-600-3 (GGG 60)

W = Schieberwinkel

Cam Angle

E = Einarbeitung

Machining

G = Gasdruckfeder

Gas spring

SE = Sensor

Sensor

W	E	G	SE	L	W1	s	S1	S2	Sz	L1	L2	L3	No.
0°	E0	G0	S0	285	47	35.5	52	38	16	285	230	50	SN5650-PMOL-0125-00-E0-G0-S0-V04
0°	E0	G0	S1	285	47	35.5	52	38	16	285	230	50	SN5650-PMOL-0125-00-E0-G0-S1-V04
0°	E0	G1	S0	285	47	35.5	52	38	16	285	230	50	SN5650-PMOL-0125-00-E0-G1-S0-V04
0°	E0	G1	S1	285	47	35.5	52	38	16	285	230	50	SN5650-PMOL-0125-00-E0-G1-S1-V04
0°	E1	G0	S0	285	47	35.5	52	38	16	285	230	50	SN5650-PMOL-0125-00-E1-G0-S0-V04
0°	E1	G0	S1	285	47	35.5	52	38	16	285	230	50	SN5650-PMOL-0125-00-E1-G0-S1-V04
0°	E1	G1	S0	285	47	35.5	52	38	16	285	230	50	SN5650-PMOL-0125-00-E1-G1-S0-V04
0°	E1	G1	S1	285	47	35.5	52	38	16	285	230	50	SN5650-PMOL-0125-00-E1-G1-S1-V04
5°	E0	G0	S0	285	45	36.9	52	40	21	285	230	50	SN5650-PMOL-0125-05-E0-G0-S0-V04
5°	E0	G0	S1	285	45	36.9	52	40	21	285	230	50	SN5650-PMOL-0125-05-E0-G0-S1-V04
5°	E0	G1	S0	285	45	36.9	52	40	21	285	230	50	SN5650-PMOL-0125-05-E0-G1-S0-V04
5°	E0	G1	S1	285	45	36.9	52	40	21	285	230	50	SN5650-PMOL-0125-05-E0-G1-S1-V04
5°	E1	G0	S0	285	45	36.9	52	40	21	285	230	50	SN5650-PMOL-0125-05-E1-G0-S0-V04
5°	E1	G0	S1	285	45	36.9	52	40	21	285	230	50	SN5650-PMOL-0125-05-E1-G0-S1-V04
5°	E1	G1	S0	285	45	36.9	52	40	21	285	230	50	SN5650-PMOL-0125-05-E1-G1-S0-V04
5°	E1	G1	S1	285	45	36.9	52	40	21	285	230	50	SN5650-PMOL-0125-05-E1-G1-S1-V04
10°	E0	G0	S0	295	42	39.2	52	41.6	22	295	220	40	SN5650-PMOL-0125-10-E0-G0-S0-V04
10°	E0	G0	S1	295	42	39.2	52	41.6	22	295	220	40	SN5650-PMOL-0125-10-E0-G0-S1-V04
10°	E0	G1	S0	295	42	39.2	52	41.6	22	295	220	40	SN5650-PMOL-0125-10-E0-G1-S0-V04
10°	E0	G1	S1	295	42	39.2	52	41.6	22	295	220	40	SN5650-PMOL-0125-10-E0-G1-S1-V04
10°	E1	G0	S0	295	42	39.2	52	41.6	22	295	220	40	SN5650-PMOL-0125-10-E1-G0-S0-V04
10°	E1	G0	S1	295	42	39.2	52	41.6	22	295	220	40	SN5650-PMOL-0125-10-E1-G0-S1-V04
10°	E1	G1	S0	295	42	39.2	52	41.6	22	295	220	40	SN5650-PMOL-0125-10-E1-G1-S0-V04
10°	E1	G1	S1	295	42	39.2	52	41.6	22	295	220	40	SN5650-PMOL-0125-10-E1-G1-S1-V04
15°	E0	G0	S0	295	40	41.2	52	44.1	22	295	220	40	SN5650-PMOL-0125-15-E0-G0-S0-V04
15°	E0	G0	S1	295	40	41.2	52	44.1	22	295	220	40	SN5650-PMOL-0125-15-E0-G0-S1-V04
15°	E0	G1	S0	295	40	41.2	52	44.1	22	295	220	40	SN5650-PMOL-0125-15-E0-G1-S0-V04
15°	E0	G1	S1	295	40	41.2	52	44.1	22	295	220	40	SN5650-PMOL-0125-15-E0-G1-S1-V04
15°	E1	G0	S0	295	40	41.2	52	44.1	22	295	220	40	SN5650-PMOL-0125-15-E1-G0-S0-V04

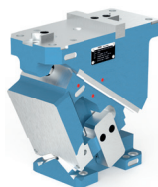

W	E	G	SE	L	W1	s	S1	S2	Sz	L1	L2	L3	No.
15°	E1	G0	S1	295	40	41.2	52	44.1	22	295	220	40	SN5650-PMOL-0125-15-E1-G0-S1-V04
15°	E1	G1	S0	295	40	41.2	52	44.1	22	295	220	40	SN5650-PMOL-0125-15-E1-G1-S0-V04
15°	E1	G1	S1	295	40	41.2	52	44.1	22	295	220	40	SN5650-PMOL-0125-15-E1-G1-S1-V04
20°	E0	G0	S0	285	37	44.2	52	46.4	27	285	180	40	SN5650-PMOL-0125-20-E0-G0-S0-V04
20°	E0	G0	S1	285	37	44.2	52	46.4	27	285	180	40	SN5650-PMOL-0125-20-E0-G0-S1-V04
20°	E0	G1	S0	285	37	44.2	52	46.4	27	285	180	40	SN5650-PMOL-0125-20-E0-G1-S0-V04
20°	E0	G1	S1	285	37	44.2	52	46.4	27	285	180	40	SN5650-PMOL-0125-20-E0-G1-S1-V04
20°	E1	G0	S0	285	37	44.2	52	46.4	27	285	180	40	SN5650-PMOL-0125-20-E1-G0-S0-V04
20°	E1	G0	S1	285	37	44.2	52	46.4	27	285	180	40	SN5650-PMOL-0125-20-E1-G0-S1-V04
20°	E1	G1	S0	285	37	44.2	52	46.4	27	285	180	40	SN5650-PMOL-0125-20-E1-G1-S0-V04
20°	E1	G1	S1	285	37	44.2	52	46.4	27	285	180	40	SN5650-PMOL-0125-20-E1-G1-S1-V04
25°	E0	G0	S0	285	35	47	52	49.7	32	285	180	40	SN5650-PMOL-0125-25-E0-G0-S0-V04
25°	E0	G0	S1	285	35	47	52	49.7	32	285	180	40	SN5650-PMOL-0125-25-E0-G0-S1-V04
25°	E0	G1	S0	285	35	47	52	49.7	32	285	180	40	SN5650-PMOL-0125-25-E0-G1-S0-V04
25°	E0	G1	S1	285	35	47	52	49.7	32	285	180	40	SN5650-PMOL-0125-25-E0-G1-S1-V04
25°	E1	G0	S0	285	35	47	52	49.7	32	285	180	40	SN5650-PMOL-0125-25-E1-G0-S0-V04
25°	E1	G0	S1	285	35	47	52	49.7	32	285	180	40	SN5650-PMOL-0125-25-E1-G0-S1-V04
25°	E1	G1	S0	285	35	47	52	49.7	32	285	180	40	SN5650-PMOL-0125-25-E1-G1-S0-V04
25°	E1	G1	S1	285	35	47	52	49.7	32	285	180	40	SN5650-PMOL-0125-25-E1-G1-S1-V04
30°	E0	G0	S0	300	32	50.9	52	53	37	300	162	45	SN5650-PMOL-0125-30-E0-G0-S0-V04
30°	E0	G0	S1	300	32	50.9	52	53	37	300	162	45	SN5650-PMOL-0125-30-E0-G0-S1-V04
30°	E0	G1	S0	300	32	50.9	52	53	37	300	162	45	SN5650-PMOL-0125-30-E0-G1-S0-V04
30°	E0	G1	S1	300	32	50.9	52	53	37	300	162	45	SN5650-PMOL-0125-30-E0-G1-S1-V04
30°	E1	G0	S0	300	32	50.9	52	53	37	300	162	45	SN5650-PMOL-0125-30-E1-G0-S0-V04
30°	E1	G0	S1	300	32	50.9	52	53	37	300	162	45	SN5650-PMOL-0125-30-E1-G0-S1-V04
30°	E1	G1	S0	300	32	50.9	52	53	37	300	162	45	SN5650-PMOL-0125-30-E1-G1-S0-V04
30°	E1	G1	S1	300	32	50.9	52	53	37	300	162	45	SN5650-PMOL-0125-30-E1-G1-S1-V04
35°	E0	G0	S0	300	30	55	52	57.5	37	300	162	45	SN5650-PMOL-0125-35-E0-G0-S0-V04
35°	E0	G0	S1	300	30	55	52	57.5	37	300	162	45	SN5650-PMOL-0125-35-E0-G0-S1-V04
35°	E0	G1	S0	300	30	55	52	57.5	37	300	162	45	SN5650-PMOL-0125-35-E0-G1-S0-V04
35°	E0	G1	S1	300	30	55	52	57.5	37	300	162	45	SN5650-PMOL-0125-35-E0-G1-S1-V04
35°	E1	G0	S0	300	30	55	52	57.5	37	300	162	45	SN5650-PMOL-0125-35-E1-G0-S0-V04
35°	E1	G0	S1	300	30	55	52	57.5	37	300	162	45	SN5650-PMOL-0125-35-E1-G0-S1-V04
35°	E1	G1	S0	300	30	55	52	57.5	37	300	162	45	SN5650-PMOL-0125-35-E1-G1-S0-V04
35°	E1	G1	S1	300	30	55	52	57.5	37	300	162	45	SN5650-PMOL-0125-35-E1-G1-S1-V04
40°	E0	G0	S0	305	27	54.7	47	56.5	37	305	152	30	SN5650-PMOL-0125-40-E0-G0-S0-V04
40°	E0	G0	S1	305	27	54.7	47	56.5	37	305	152	30	SN5650-PMOL-0125-40-E0-G0-S1-V04
40°	E0	G1	S0	305	27	54.7	47	56.5	37	305	152	30	SN5650-PMOL-0125-40-E0-G1-S0-V04
40°	E0	G1	S1	305	27	54.7	47	56.5	37	305	152	30	SN5650-PMOL-0125-40-E0-G1-S1-V04
40°	E1	G0	S0	305	27	54.7	47	56.5	37	305	152	30	SN5650-PMOL-0125-40-E1-G0-S0-V04
40°	E1	G0	S1	305	27	54.7	47	56.5	37	305	152	30	SN5650-PMOL-0125-40-E1-G0-S1-V04
40°	E1	G1	S0	305	27	54.7	47	56.5	37	305	152	30	SN5650-PMOL-0125-40-E1-G1-S0-V04
40°	E1	G1	S1	305	27	54.7	47	56.5	37	305	152	30	SN5650-PMOL-0125-40-E1-G1-S1-V04
45°	E0	G0	S0	305	25	60.2	47	62.5	42	305	152	30	SN5650-PMOL-0125-45-E0-G0-S0-V04
45°	E0	G0	S1	305	25	60.2	47	62.5	42	305	152	30	SN5650-PMOL-0125-45-E0-G0-S1-V04
45°	E0	G1	S0	305	25	60.2	47	62.5	42	305	152	30	SN5650-PMOL-0125-45-E0-G1-S0-V04
45°	E0	G1	S1	305	25	60.2	47	62.5	42	305	152	30	SN5650-PMOL-0125-45-E0-G1-S1-V04
45°	E1	G0	S0	305	25	60.2	47	62.5	42	305	152	30	SN5650-PMOL-0125-45-E1-G0-S0-V04
45°	E1	G0	S1	305	25	60.2	47	62.5	42	305	152	30	SN5650-PMOL-0125-45-E1-G0-S1-V04
45°	E1	G1	S0	305	25	60.2	47	62.5	42	305	152	30	SN5650-PMOL-0125-45-E1-G1-S0-V04
45°	E1	G1	S1	305	25	60.2	47	62.5	42	305	152	30	SN5650-PMOL-0125-45-E1-G1-S1-V04
50°	E0	G0	S0	305	22	67.8	47	69.5	47	305	140	20	SN5650-PMOL-0125-50-E0-G0-S0-V04
50°	E0	G0	S1	305	22	67.8	47	69.5	47	305	140	20	SN5650-PMOL-0125-50-E0-G0-S1-V04
50°	E0	G1	S0	305	22	67.8	47	69.5	47	305	140	20	SN5650-PMOL-0125-50-E0-G1-S0-V04
50°	E0	G1	S1	305	22	67.8	47	69.5	47	305	140	20	SN5650-PMOL-0125-50-E0-G1-S1-V04

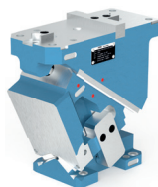

W	E	G	SE	L	W1	s	S1	S2	Sz	L1	L2	L3	No.
50°	E1	G0	S0	305	22	67.8	47	69.5	47	305	140	20	SN5650-PMOL-0125-50-E1-G0-S0-V04
50°	E1	G0	S1	305	22	67.8	47	69.5	47	305	140	20	SN5650-PMOL-0125-50-E1-G0-S1-V04
50°	E1	G1	S0	305	22	67.8	47	69.5	47	305	140	20	SN5650-PMOL-0125-50-E1-G1-S0-V04
50°	E1	G1	S1	305	22	67.8	47	69.5	47	305	140	20	SN5650-PMOL-0125-50-E1-G1-S1-V04
55°	E0	G0	S0	305	20	68.8	42	70.7	47	305	140	20	SN5650-PMOL-0125-55-E0-G0-S0-V04
55°	E0	G0	S1	305	20	68.8	42	70.7	47	305	140	20	SN5650-PMOL-0125-55-E0-G0-S1-V04
55°	E0	G1	S0	305	20	68.8	42	70.7	47	305	140	20	SN5650-PMOL-0125-55-E0-G1-S0-V04
55°	E0	G1	S1	305	20	68.8	42	70.7	47	305	140	20	SN5650-PMOL-0125-55-E0-G1-S1-V04
55°	E1	G0	S0	305	20	68.8	42	70.7	47	305	140	20	SN5650-PMOL-0125-55-E1-G0-S0-V04
55°	E1	G0	S1	305	20	68.8	42	70.7	47	305	140	20	SN5650-PMOL-0125-55-E1-G0-S1-V04
55°	E1	G1	S0	305	20	68.8	42	70.7	47	305	140	20	SN5650-PMOL-0125-55-E1-G1-S0-V04
55°	E1	G1	S1	305	20	68.8	42	70.7	47	305	140	20	SN5650-PMOL-0125-55-E1-G1-S1-V04
60°	E0	G0	S0	315	17	70.8	37	72.1	27	315	128	20	SN5650-PMOL-0125-60-E0-G0-S0-V04
60°	E0	G0	S1	315	17	70.8	37	72.1	27	315	128	20	SN5650-PMOL-0125-60-E0-G0-S1-V04
60°	E0	G1	S0	315	17	70.8	37	72.1	27	315	128	20	SN5650-PMOL-0125-60-E0-G1-S0-V04
60°	E0	G1	S1	315	17	70.8	37	72.1	27	315	128	20	SN5650-PMOL-0125-60-E0-G1-S1-V04
60°	E1	G0	S0	315	17	70.8	37	72.1	27	315	128	20	SN5650-PMOL-0125-60-E1-G0-S0-V04
60°	E1	G0	S1	315	17	70.8	37	72.1	27	315	128	20	SN5650-PMOL-0125-60-E1-G0-S1-V04
60°	E1	G1	S0	315	17	70.8	37	72.1	27	315	128	20	SN5650-PMOL-0125-60-E1-G1-S0-V04
60°	E1	G1	S1	315	17	70.8	37	72.1	27	315	128	20	SN5650-PMOL-0125-60-E1-G1-S1-V04
65°	E0	G0	S0	315	15	73.1	32	74.6	27	315	128	20	SN5650-PMOL-0125-65-E0-G0-S0-V04
65°	E0	G0	S1	315	15	73.1	32	74.6	27	315	128	20	SN5650-PMOL-0125-65-E0-G0-S1-V04
65°	E0	G1	S0	315	15	73.1	32	74.6	27	315	128	20	SN5650-PMOL-0125-65-E0-G1-S0-V04
65°	E0	G1	S1	315	15	73.1	32	74.6	27	315	128	20	SN5650-PMOL-0125-65-E0-G1-S1-V04
65°	E1	G0	S0	315	15	73.1	32	74.6	27	315	128	20	SN5650-PMOL-0125-65-E1-G0-S0-V04
65°	E1	G0	S1	315	15	73.1	32	74.6	27	315	128	20	SN5650-PMOL-0125-65-E1-G0-S1-V04
65°	E1	G1	S0	315	15	73.1	32	74.6	27	315	128	20	SN5650-PMOL-0125-65-E1-G1-S0-V04
65°	E1	G1	S1	315	15	73.1	32	74.6	27	315	128	20	SN5650-PMOL-0125-65-E1-G1-S1-V04
70°	E0	G0	S0	325	12	77.2	27	78.2	47	325	118	15	SN5650-PMOL-0125-70-E0-G0-S0-V04
70°	E0	G0	S1	325	12	77.2	27	78.2	47	325	118	15	SN5650-PMOL-0125-70-E0-G0-S1-V04
70°	E0	G1	S0	325	12	77.2	27	78.2	47	325	118	15	SN5650-PMOL-0125-70-E0-G1-S0-V04
70°	E0	G1	S1	325	12	77.2	27	78.2	47	325	118	15	SN5650-PMOL-0125-70-E0-G1-S1-V04
70°	E1	G0	S0	325	12	77.2	27	78.2	47	325	118	15	SN5650-PMOL-0125-70-E1-G0-S0-V04
70°	E1	G0	S1	325	12	77.2	27	78.2	47	325	118	15	SN5650-PMOL-0125-70-E1-G0-S1-V04
70°	E1	G1	S0	325	12	77.2	27	78.2	47	325	118	15	SN5650-PMOL-0125-70-E1-G1-S0-V04
70°	E1	G1	S1	325	12	77.2	27	78.2	47	325	118	15	SN5650-PMOL-0125-70-E1-G1-S1-V04
75°	E0	G0	S0	325	10	83.7	22	84.7	47	325	118	15	SN5650-PMOL-0125-75-E0-G0-S0-V04
75°	E0	G0	S1	325	10	83.7	22	84.7	47	325	118	15	SN5650-PMOL-0125-75-E0-G0-S1-V04
75°	E0	G1	S0	325	10	83.7	22	84.7	47	325	118	15	SN5650-PMOL-0125-75-E0-G1-S0-V04
75°	E0	G1	S1	325	10	83.7	22	84.7	47	325	118	15	SN5650-PMOL-0125-75-E0-G1-S1-V04
75°	E1	G0	S0	325	10	83.7	22	84.7	47	325	118	15	SN5650-PMOL-0125-75-E1-G0-S0-V04
75°	E1	G0	S1	325	10	83.7	22	84.7	47	325	118	15	SN5650-PMOL-0125-75-E1-G0-S1-V04
75°	E1	G1	S0	325	10	83.7	22	84.7	47	325	118	15	SN5650-PMOL-0125-75-E1-G1-S0-V04
75°	E1	G1	S1	325	10	83.7	22	84.7	47	325	118	15	SN5650-PMOL-0125-75-E1-G1-S1-V04

SN5650-PMOL-0125-

Kraftverteilung

Force Distribution

500.000 Stroke

W	FS [kN]	FP [kN]	Fh1 [kN]	FW [kN]	Fh2 [kN]	h1 [mm]	h2 [mm]	FA [kN]
00°	276	260	276	260	0	165	30	28
05°	287	271	264	260	20	158	43	28
10°	297	283	252	260	41	150	55	27
15°	306	292	238	260	56	148	60	27
20°	315	302	225	260	71	146	65	26
25°	334	321	218	260	83	131	64	26
30°	353	341	211	260	95	115	62	25
35°	361	349	196	260	98	108	73	28
40°	368	357	180	260	101	100	84	30
45°	375	365	165	260	99	86	94	30
50°	381	372	149	260	96	72	103	30
55°	381	373	131	260	87	71	115	30
60°	380	374	113	260	77	70	127	29
65°	384	377	100	260	63	70	125	30
70°	401	395	86	260	49	64	128	30
75°	417	413	71	260	36	58	130	30

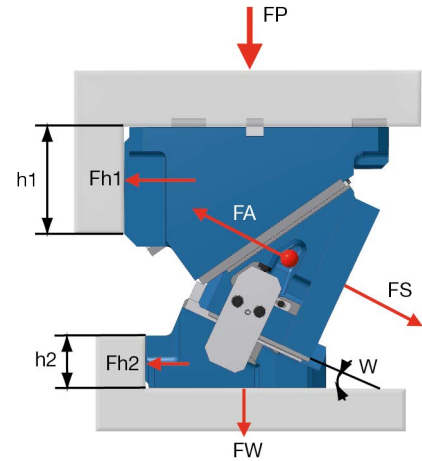

1.000.000 Stroke

W	FS [kN]	FP [kN]	Fh1 [kN]	FW [kN]	Fh2 [kN]	h1 [mm]	h2 [mm]	FA [kN]
00°	207	196	207	196	0	165	30	28
05°	215	204	198	185	15	158	43	28
10°	223	213	189	174	31	150	55	27
15°	230	220	179	160	42	148	60	27
20°	236	227	169	146	53	146	65	26
25°	251	242	163	135	62	131	64	26
30°	265	256	158	123	71	115	62	25
35°	270	262	147	107	74	108	73	28
40°	276	268	135	91	76	100	84	30
45°	281	274	123	76	74	86	94	30
50°	286	280	111	61	72	72	103	30
55°	285	280	98	47	65	71	115	30
60°	285	280	84	34	58	70	127	29
65°	288	283	75	22	47	70	125	30
70°	300	296	64	15	37	64	128	30
75°	313	309	53	7	28	58	130	30

SN5650-PMOL-0125-

Schieberkräfte

Cam Force

Abschulterung

Shouldering

Passfeder

Fitting Key

SN5650-PMOL-0125-0°

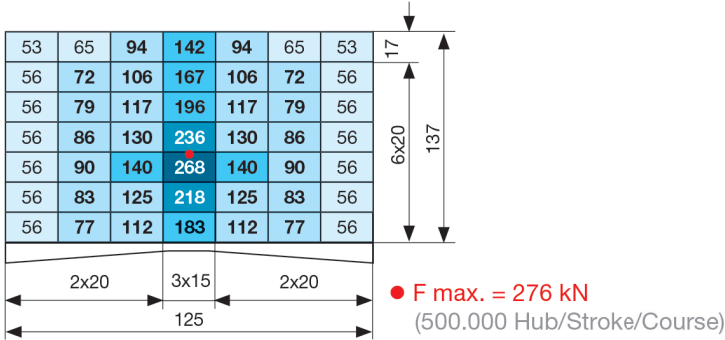

53	57	61	61	61	57	53
53	57	61	65	61	57	53
53	57	61	65	61	57	53
53	57	61	65	61	57	53
53	57	61	65	61	57	53
53	57	61	65	61	57	53
53	57	61	65	61	57	53

SN5650-PMOL-0125-5°

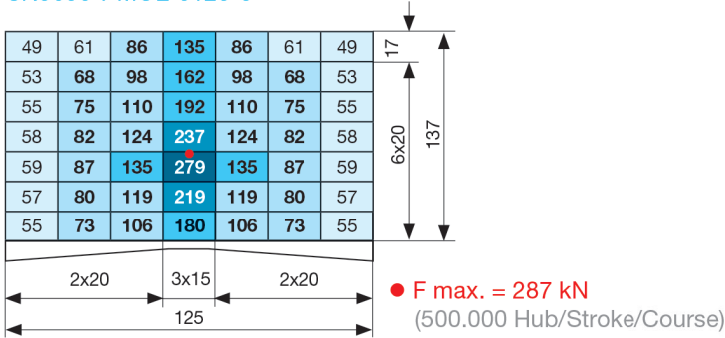

49	57	66	66	66	57	49
52	60	66	71	66	60	52
54	62	66	71	66	62	54
56	62	66	71	66	62	56
57	62	66	71	66	62	57
56	62	66	71	66	62	56
54	62	66	71	66	62	54

SN5650-PMOL-0125-10°

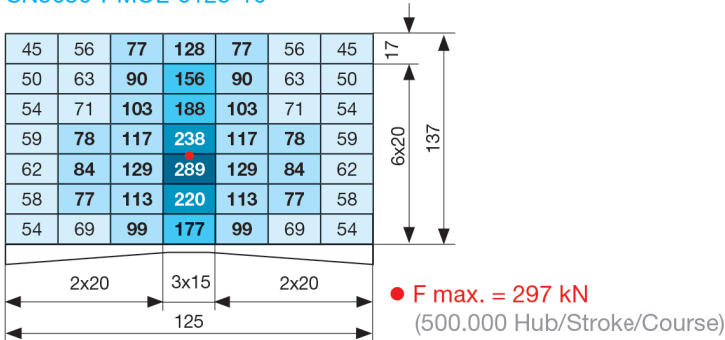

45	56	71	71	71	56	45
50	63	71	77	71	63	50
54	66	71	77	71	66	54
59	66	71	77	71	66	59
60	66	71	77	71	66	60
58	66	71	77	71	66	58
54	66	71	77	71	66	54

SN5650-PMOL-0125-15°

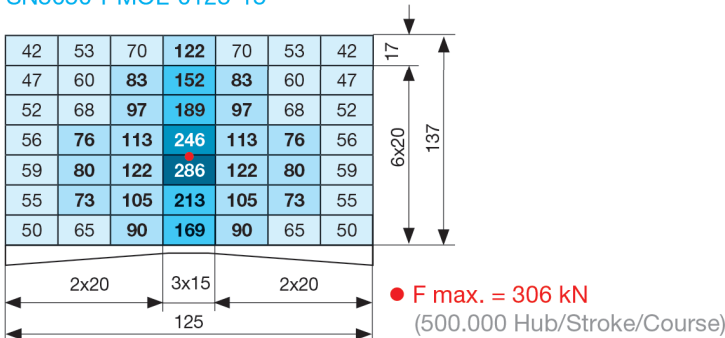

42	53	67	67	67	53	42
47	60	73	84	73	60	47
52	66	77	84	77	66	52
56	70	77	84	77	70	56
58	70	77	84	77	70	58
55	67	77	84	77	67	55
50	63	76	84	76	63	50

SN5650-PMOL-0125-

Schieberkräfte

Cam Force

Abschulterung

Shouldering

Passfeder

Fitting Key

SN5650-PMOL-0125-20°

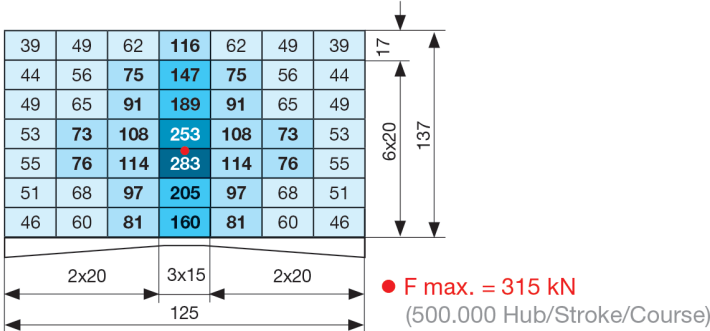

39	49	62	62	62	49	39
44	56	75	91	75	56	44
49	65	82	91	82	65	49
53	73	82	91	82	73	53
55	73	82	91	82	73	55
51	68	82	91	82	68	51
46	60	81	91	81	60	46

SN5650-PMOL-0125-25°

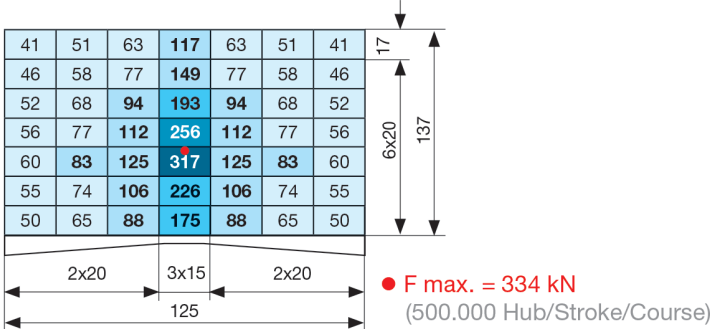

41	51	63	86	63	51	41
46	58	77	101	77	58	46
52	68	90	101	90	68	52
56	77	90	101	90	77	56
60	80	90	101	90	80	60
55	74	90	101	90	74	55
50	65	88	101	88	65	50

SN5650-PMOL-0125-30°

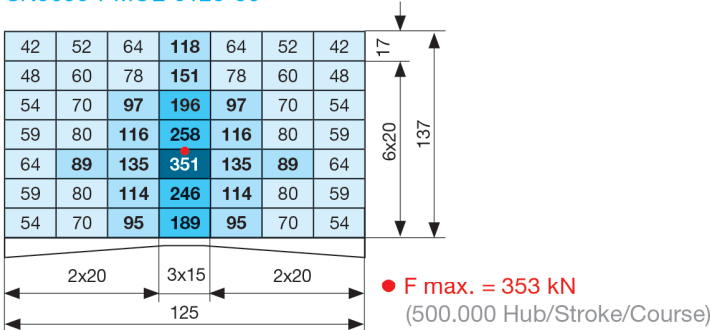

42	52	64	110	64	52	42
48	60	78	110	78	60	48
54	70	97	110	97	70	54
59	80	98	110	98	80	59
64	87	98	110	98	87	64
59	80	98	110	98	80	59
54	70	95	110	95	70	54

SN5650-PMOL-0125-35°

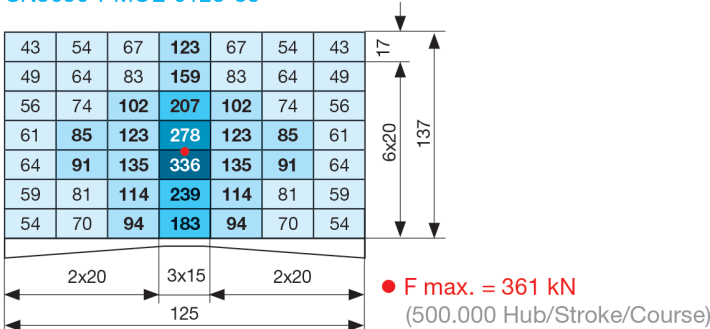

43	54	67	119	67	54	43
49	64	83	122	83	64	49
56	74	102	122	102	74	56
61	85	109	122	109	85	61
64	90	109	122	109	90	64
59	81	106	122	106	81	59
54	70	94	122	94	70	54

D 1801D 06.2022

SN5650-PMOL-0125-

Schieberkräfte

Cam Force

Abschulterung

Shouldering

Passfeder

Fitting Key

SN5650-PMOL-0125-40°

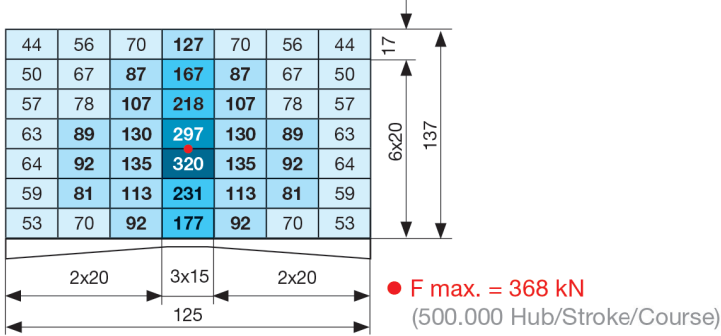

44	56	70	127	70	56	44
50	67	87	134	87	67	50
57	78	107	134	107	78	57
63	89	120	134	120	89	63
64	92	120	134	120	92	64
59	81	113	134	113	81	59
53	70	92	134	92	70	53

SN5650-PMOL-0125-45°

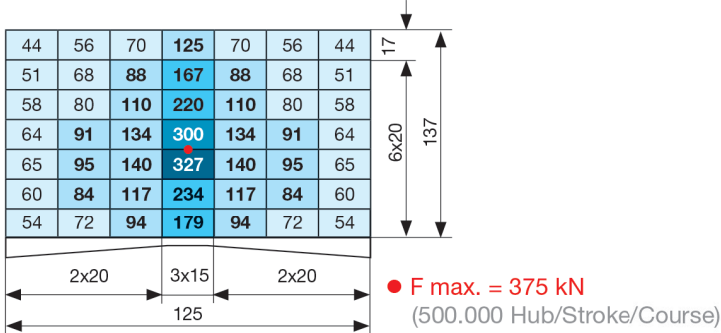

44	56	70	125	70	56	44
51	68	88	150	88	68	51
58	80	110	152	110	80	58
64	91	129	152	129	91	64
65	95	133	152	133	95	65
60	84	117	152	117	84	60
54	72	94	152	94	72	54

SN5650-PMOL-0125-50°

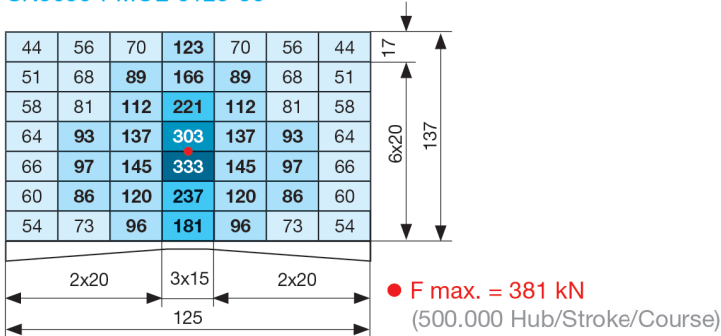

44	56	70	123	70	56	44
51	68	89	166	89	68	51
58	81	112	169	112	81	58
64	93	137	169	137	93	64
66	97	145	169	145	97	66
60	86	120	169	120	86	60
54	73	96	169	96	73	54

SN5650-PMOL-0125-55°

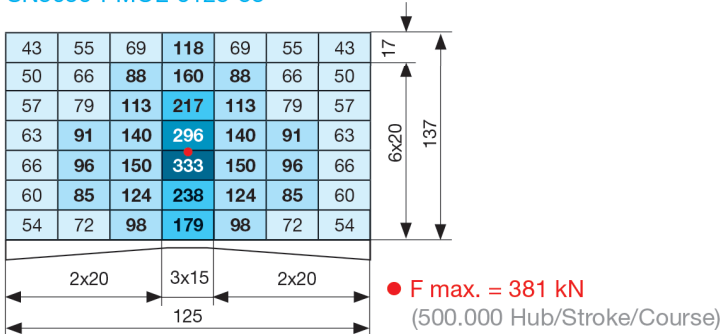

43	55	69	118	69	55	43
50	66	88	160	88	66	50
57	79	113	191	113	79	57
63	91	140	196	140	91	63
66	96	150	196	150	96	66
60	85	124	196	124	85	60
54	72	98	173	98	72	54

SN5650-PMOL-0125-

Schieberkräfte

Cam Force

Abschulterung

Shouldering

Passfeder

Fitting Key

SN5650-PMOL-0125-60°

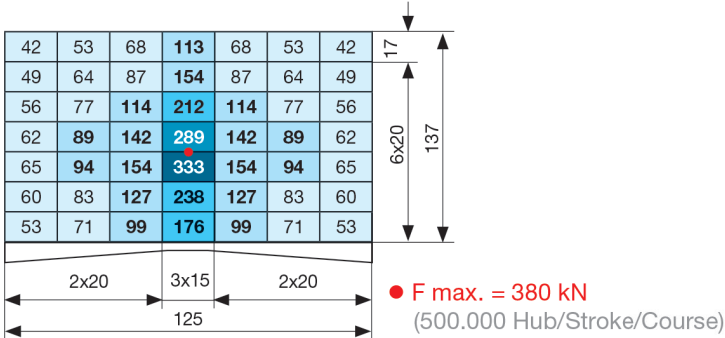

42	53	68	113	68	53	42
49	64	87	154	87	64	49
56	77	114	212	114	77	56
62	89	142	222	142	89	62
65	94	154	222	154	94	65
60	83	127	222	127	83	60
53	71	99	176	99	71	53

SN5650-PMOL-0125-65°

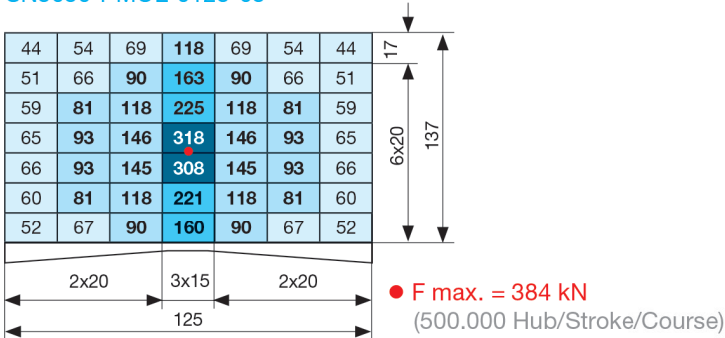

44	54	69	118	69	54	44
51	66	90	163	90	66	51
59	81	118	225	118	81	59
65	93	146	254	146	93	65
66	93	145	254	145	93	66
60	81	118	221	118	81	60
52	67	90	160	90	67	52

SN5650-PMOL-0125-70°

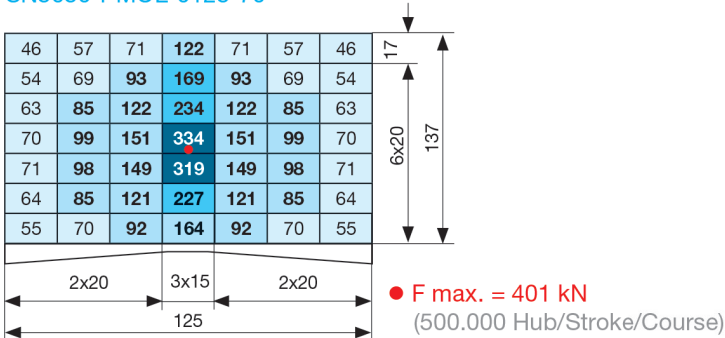

46	57	71	122	71	57	46
54	69	93	169	93	69	54
63	85	122	234	122	85	63
70	99	151	302	151	99	70
71	98	149	292	149	98	71
64	85	121	227	121	85	64
55	70	92	164	92	70	55

SN5650-PMOL-0125-75°

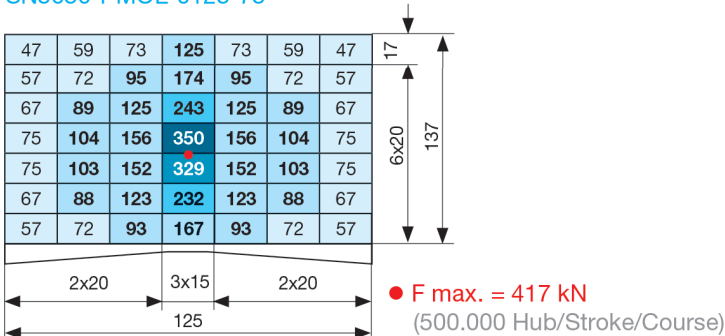

48	59	73	125	73	59	48
57	72	95	174	95	72	57
67	89	125	243	125	89	67
75	104	156	350	156	104	75
75	103	152	329	152	103	75
67	88	123	232	123	88	67
57	72	93	167	93	72	57

SN5650-PMOL-0125-

Schieberkräfte

Cam Force

Abschulterung

Shouldering

Passfeder

Fitting Key

SN5650-PMOL-0125-0°

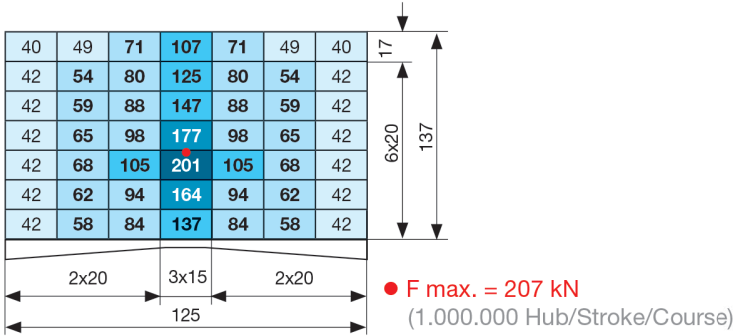

40	43	46	46	46	43	40
40	43	46	49	46	43	40
40	43	46	49	46	43	40
40	43	46	49	46	43	40
40	43	46	49	46	43	40
40	43	46	49	46	43	40
40	43	46	49	46	43	40
40	43	46	49	46	43	40

SN5650-PMOL-0125-5°

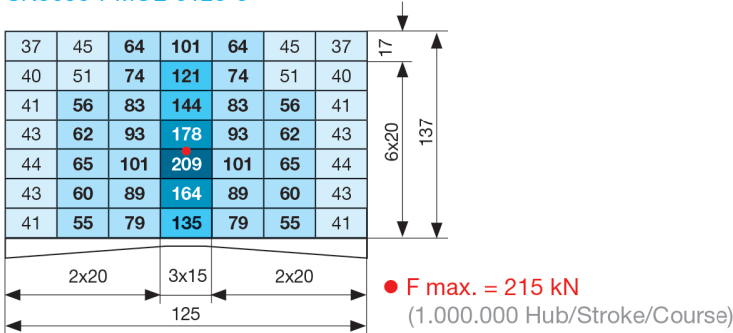

37	42	50	50	50	42	37
39	45	50	53	50	45	39
40	46	50	53	50	46	40
42	46	50	53	50	46	42
42	46	50	53	50	46	42
42	46	50	53	50	46	42
40	46	50	53	50	46	40

SN5650-PMOL-0125-10°

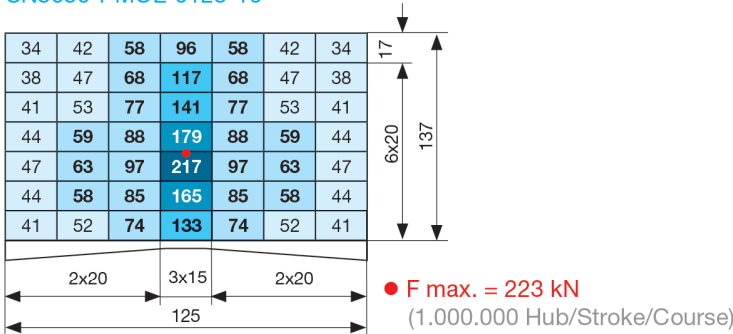

34	42	53	53	53	42	34
38	47	53	58	53	47	38
41	50	53	58	53	50	41
44	50	53	58	53	50	44
45	50	53	58	53	50	45
44	50	53	58	53	50	44
41	50	53	58	53	50	41

SN5650-PMOL-0125-15°

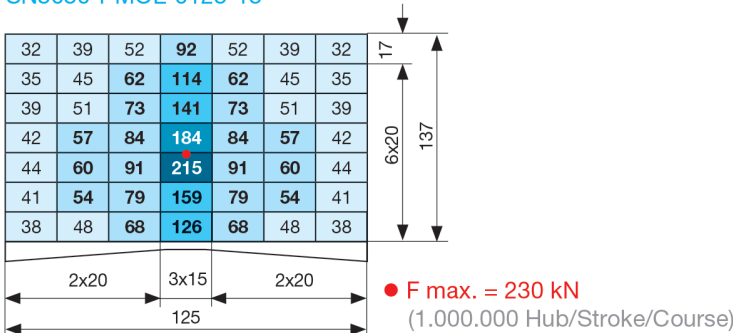

32	39	50	50	50	39	32
35	45	55	63	55	45	35
39	49	57	63	57	49	39
42	52	57	63	57	52	42
43	52	57	63	57	52	43
41	50	57	63	57	50	41
38	47	57	63	57	47	38

SN5650-PMOL-0125-

Schieberkräfte

Cam Force

Abschulterung

Shouldering

Passfeder

Fitting Key

SN5650-PMOL-0125-20°

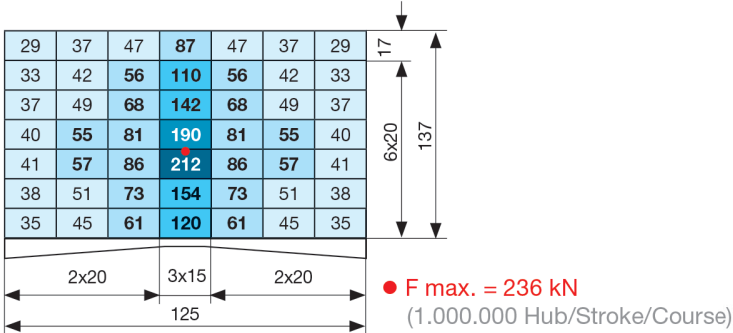

29	37	47	47	47	37	29
33	42	56	68	56	42	33
37	49	62	68	62	49	37
40	55	62	68	62	55	40
41	55	62	68	62	55	41
38	51	62	68	62	51	38
35	45	61	68	61	45	35

SN5650-PMOL-0125-25°

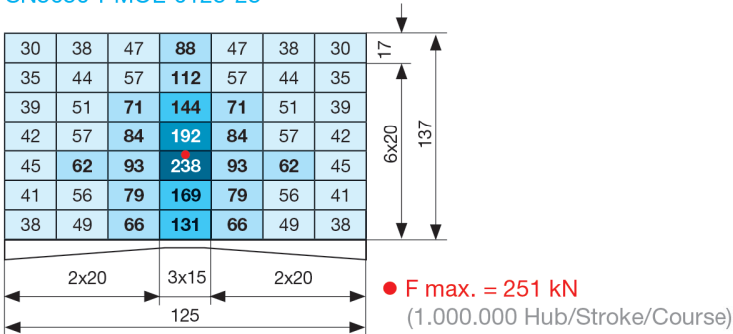

30	38	47	65	47	38	30
35	44	57	75	57	44	35
39	51	67	75	67	51	39
42	57	68	75	68	57	42
45	60	68	75	68	60	45
41	56	68	75	68	56	41
38	49	66	75	66	49	38

SN5650-PMOL-0125-30°

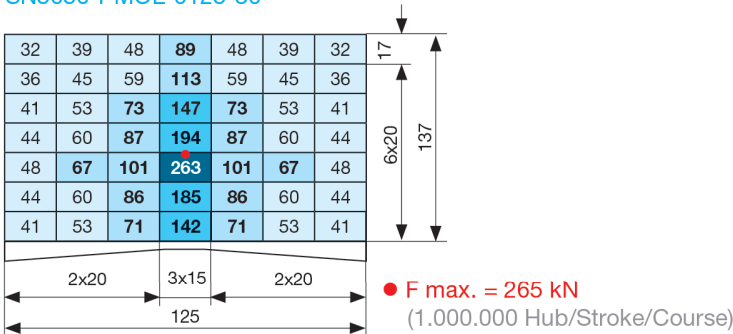

32	39	48	83	48	39	32
36	45	59	83	59	45	36
41	53	73	83	73	53	41
44	60	74	83	74	60	44
48	65	74	83	74	65	48
44	60	74	83	74	60	44
41	53	71	83	71	53	41

SN5650-PMOL-0125-35°

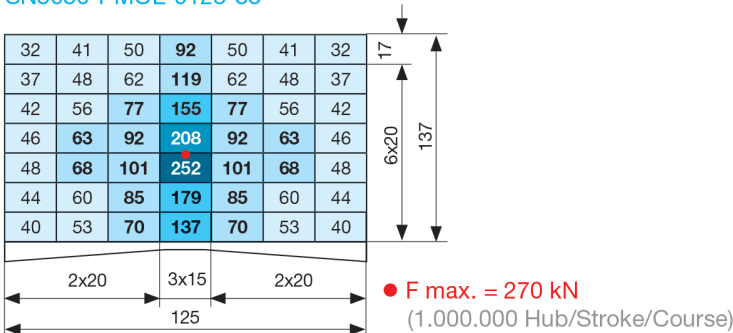

32	41	50	89	50	41	32
37	48	62	92	62	48	37
42	56	77	92	77	56	42
46	63	82	92	82	63	46
48	67	82	92	82	67	48
44	60	79	92	79	60	44
40	53	70	92	70	53	40

D 1801D 06.2022

SN5650-PMOL-0125-

Schieberkräfte

Cam Force

Abschulterung

Shouldering

Passfeder

Fitting Key

SN5650-PMOL-0125-40°

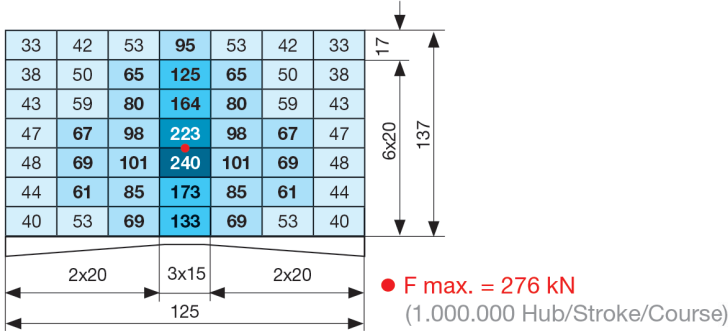

33	42	53	95	53	42	33
38	50	65	101	65	50	38
43	59	80	101	80	59	43
47	67	90	101	90	67	47
48	69	90	101	90	69	48
44	61	85	101	85	61	44
40	53	69	101	69	53	40

SN5650-PMOL-0125-45°

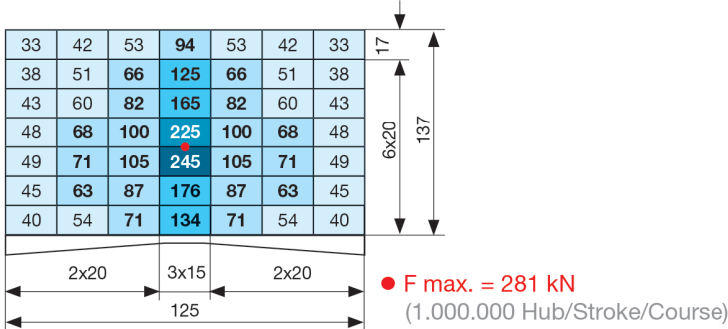

33	42	53	94	53	42	33
38	51	66	113	66	51	38
43	60	82	114	82	60	43
48	68	96	114	96	68	48
49	71	99	114	99	71	49
45	63	87	114	87	63	45
40	54	71	114	71	54	40

SN5650-PMOL-0125-50°

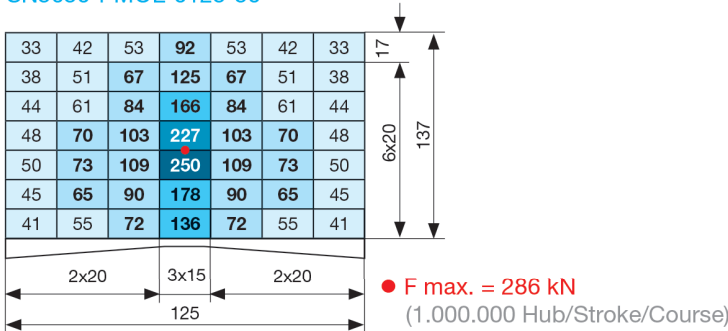

33	42	53	92	53	42	33
38	51	67	125	67	51	38
44	61	84	127	84	61	44
48	70	103	127	103	70	48
50	73	109	127	109	73	50
45	65	90	127	90	65	45
41	55	72	127	72	55	41

SN5650-PMOL-0125-55°

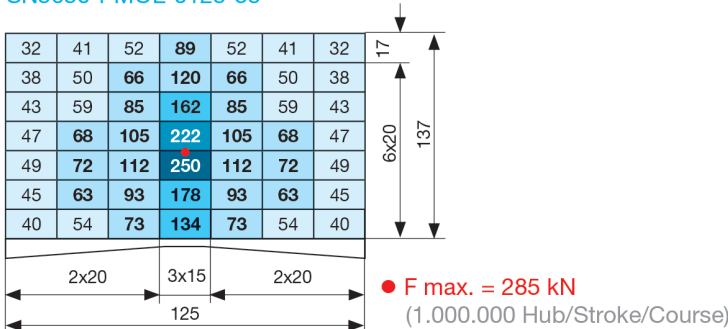

32	41	52	89	52	41	32
38	50	66	120	66	50	38
43	59	85	143	85	59	43
47	68	105	147	105	68	47
49	72	112	147	112	72	49
45	63	93	147	93	63	45
40	54	73	129	73	54	40

SN5650-PMOL-0125-

Schieberkräfte

Cam Force

Abschulterung

Shouldering

Passfeder

Fitting Key

SN5650-PMOL-0125-60°

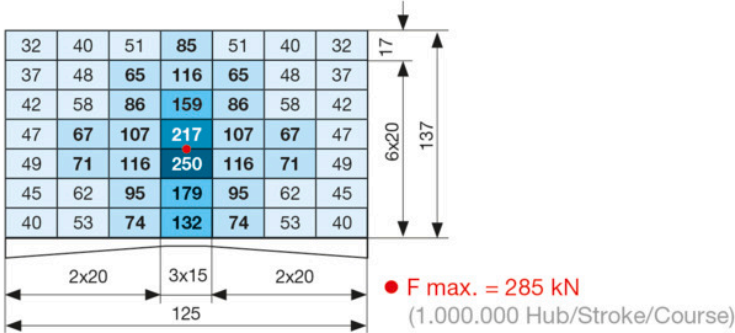

32	40	51	85	51	40	32
37	48	65	116	65	48	37
42	58	86	159	86	58	42
47	67	107	167	107	67	47
49	71	116	167	116	71	49
45	62	95	167	95	62	45
40	53	74	132	74	53	40

SN5650-PMOL-0125-65°

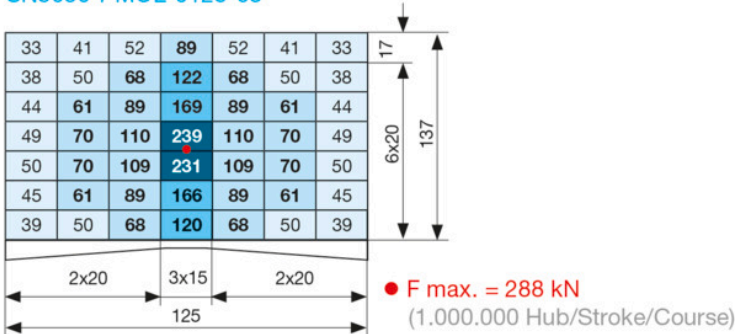

33	41	52	89	52	41	33
38	50	68	122	68	50	38
44	61	89	169	89	61	44
49	70	110	191	110	70	49
50	70	109	191	109	70	50
45	61	89	166	89	61	45
39	50	68	120	68	50	39

SN5650-PMOL-0125-70°

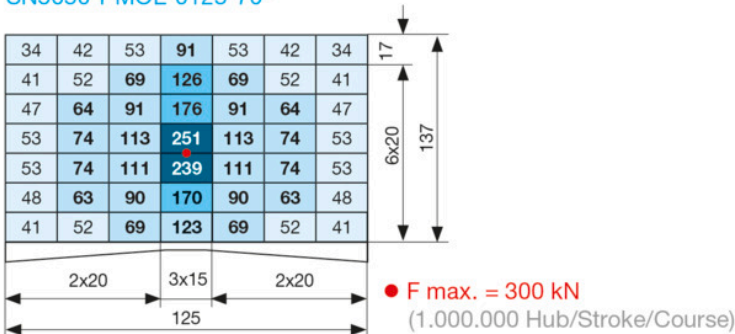

35	42	53	91	53	42	35
41	52	69	126	69	52	41
47	64	91	176	91	64	47
53	74	113	227	113	74	53
53	74	111	219	111	74	53
48	63	90	170	90	63	48
41	52	69	123	69	52	41

SN5650-PMOL-0125-75°

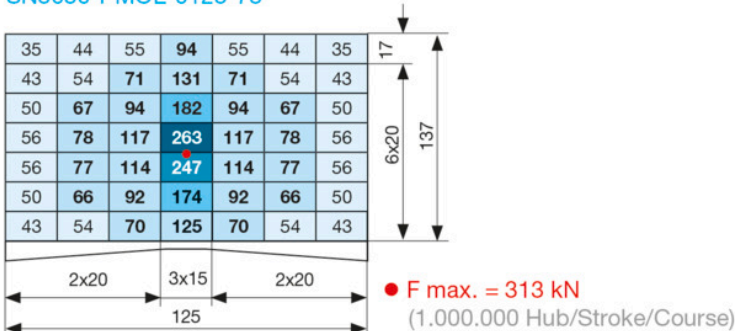

36	44	55	94	55	44	36
43	54	71	131	71	54	43
50	67	94	182	94	67	50
56	78	117	263	117	78	56
56	77	114	247	114	77	56
50	66	92	174	92	66	50
43	54	70	125	70	54	43