

## SN5650-PMOKL-0400-

### Oben hängender Kompakt-L-Schieber

Compact-L aerial standard cam

<b>Arbeitsfläche</b>	<i>Working area</i>	400 x 150 mm
<b>Schieberbreite max.</b>	<i>Cam unit width max.</i>	400 mm
<b>Einbauhöhe</b>	<i>Installation height</i>	375 mm
<b>Schieberkraft</b>	<i>Cam force</i>	> 964 kN

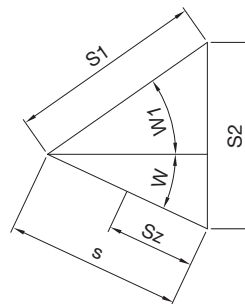
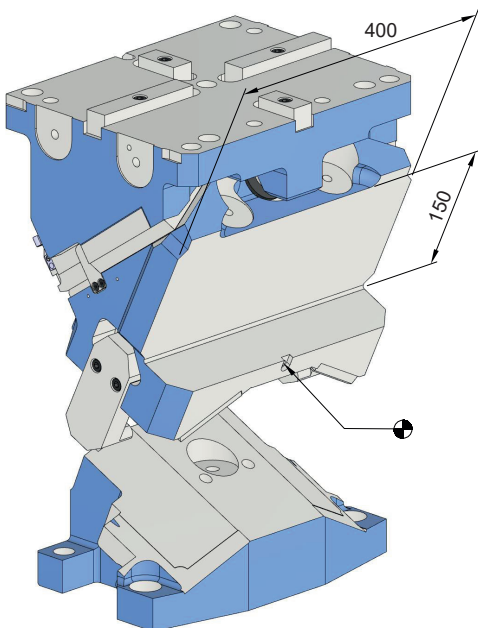
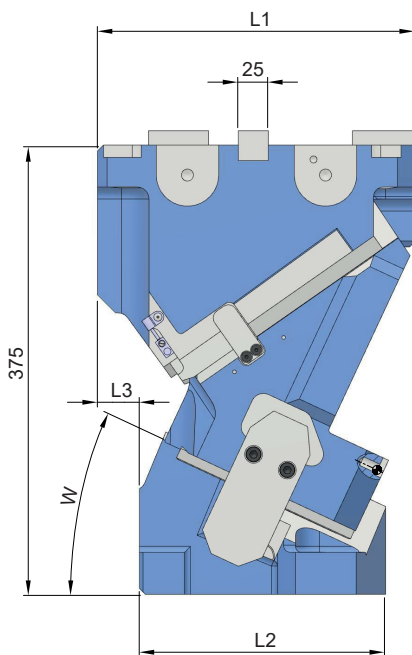

Gusstoleranzgrad CT  
nach DIN ISO 8062

(blau = Rohgussfläche)

Casting tolerance grade CT  
according to DIN ISO 8062

(blue = raw casting area)

#### Positionskontrolle: Control of position:



#### Pos. 1

Schieber zusammengefahren  
Cam is moved together



#### Pos. 2

Schieber ausgefahren  
Cam is extended

Sz = Eingriffslänge Aktivrückzug  
Sz = Engagement length of activ return

## SN5650-PMOKL-0400-

### Oben hängender Kompakt-L-Schieber

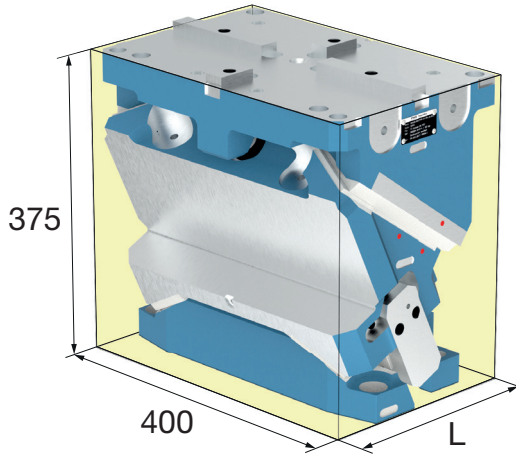

Mat.: EN-GJS-600-3 (GGG 60)

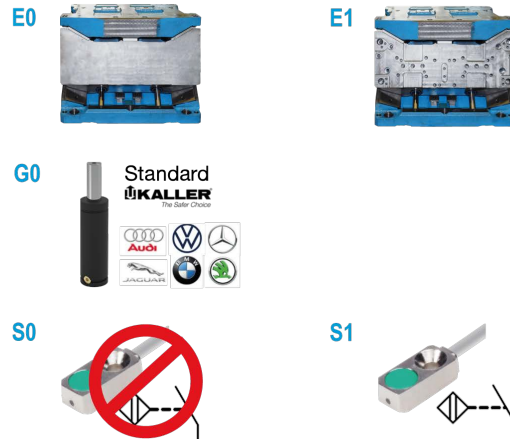

W = Schieberwinkel  
Cam Angle  
E = Einarbeitung  
Machining

G = Gasdruckfeder  
Gas spring  
SE = Sensor  
Sensor

W	E	G	SE	L	W1	s	S1	S2	Sz	L1	L2	L3	No.
0°	E0	G0	S0	265	47	35.5	52	38	20.4	265	225	30	SN5650-PMOKL-0400-00-E0-G0-S0-V04
0°	E0	G0	S1	265	47	35.5	52	38	20.4	265	225	30	SN5650-PMOKL-0400-00-E0-G0-S1-V04
0°	E0	G1	S0	265	47	35.5	52	38	20.4	265	225	30	SN5650-PMOKL-0400-00-E0-G1-S0-V04
0°	E0	G1	S1	265	47	35.5	52	38	20.4	265	225	30	SN5650-PMOKL-0400-00-E0-G1-S1-V04
0°	E1	G0	S0	265	47	35.5	52	38	20.4	265	225	30	SN5650-PMOKL-0400-00-E1-G0-S0-V04
0°	E1	G0	S1	265	47	35.5	52	38	20.4	265	225	30	SN5650-PMOKL-0400-00-E1-G0-S1-V04
0°	E1	G1	S0	265	47	35.5	52	38	20.4	265	225	30	SN5650-PMOKL-0400-00-E1-G1-S0-V04
0°	E1	G1	S1	265	47	35.5	52	38	20.4	265	225	30	SN5650-PMOKL-0400-00-E1-G1-S1-V04
5°	E0	G0	S0	265	45	36.9	52	40	20.4	265	225	30	SN5650-PMOKL-0400-05-E0-G0-S0-V04
5°	E0	G0	S1	265	45	36.9	52	40	20.4	265	225	30	SN5650-PMOKL-0400-05-E0-G0-S1-V04
5°	E0	G1	S0	265	45	36.9	52	40	20.4	265	225	30	SN5650-PMOKL-0400-05-E0-G1-S0-V04
5°	E0	G1	S1	265	45	36.9	52	40	20.4	265	225	30	SN5650-PMOKL-0400-05-E0-G1-S1-V04
5°	E1	G0	S0	265	45	36.9	52	40	20.4	265	225	30	SN5650-PMOKL-0400-05-E1-G0-S0-V04
5°	E1	G0	S1	265	45	36.9	52	40	20.4	265	225	30	SN5650-PMOKL-0400-05-E1-G0-S1-V04
5°	E1	G1	S0	265	45	36.9	52	40	20.4	265	225	30	SN5650-PMOKL-0400-05-E1-G1-S0-V04
5°	E1	G1	S1	265	45	36.9	52	40	20.4	265	225	30	SN5650-PMOKL-0400-05-E1-G1-S1-V04
10°	E0	G0	S0	265	42	39.2	52	41.6	26.4	265	220	30	SN5650-PMOKL-0400-10-E0-G0-S0-V04
10°	E0	G0	S1	265	42	39.2	52	41.6	26.4	265	220	30	SN5650-PMOKL-0400-10-E0-G0-S1-V04
10°	E0	G1	S0	265	42	39.2	52	41.6	26.4	265	220	30	SN5650-PMOKL-0400-10-E0-G1-S0-V04
10°	E0	G1	S1	265	42	39.2	52	41.6	26.4	265	220	30	SN5650-PMOKL-0400-10-E0-G1-S1-V04
10°	E1	G0	S0	265	42	39.2	52	41.6	26.4	265	220	30	SN5650-PMOKL-0400-10-E1-G0-S0-V04
10°	E1	G0	S1	265	42	39.2	52	41.6	26.4	265	220	30	SN5650-PMOKL-0400-10-E1-G0-S1-V04
10°	E1	G1	S0	265	42	39.2	52	41.6	26.4	265	220	30	SN5650-PMOKL-0400-10-E1-G1-S0-V04
10°	E1	G1	S1	265	42	39.2	52	41.6	26.4	265	220	30	SN5650-PMOKL-0400-10-E1-G1-S1-V04
15°	E0	G0	S0	265	40	41.2	52	44.1	26.4	265	220	30	SN5650-PMOKL-0400-15-E0-G0-S0-V04
15°	E0	G0	S1	265	40	41.2	52	44.1	26.4	265	220	30	SN5650-PMOKL-0400-15-E0-G0-S1-V04
15°	E0	G1	S0	265	40	41.2	52	44.1	26.4	265	220	30	SN5650-PMOKL-0400-15-E0-G1-S0-V04
15°	E0	G1	S1	265	40	41.2	52	44.1	26.4	265	220	30	SN5650-PMOKL-0400-15-E0-G1-S1-V04
15°	E1	G0	S0	265	40	41.2	52	44.1	26.4	265	220	30	SN5650-PMOKL-0400-15-E1-G0-S0-V04
15°	E1	G0	S1	265	40	41.2	52	44.1	26.4	265	220	30	SN5650-PMOKL-0400-15-E1-G0-S1-V04
15°	E1	G1	S0	265	40	41.2	52	44.1	26.4	265	220	30	SN5650-PMOKL-0400-15-E1-G1-S0-V04
15°	E1	G1	S1	265	40	41.2	52	44.1	26.4	265	220	30	SN5650-PMOKL-0400-15-E1-G1-S1-V04
20°	E0	G0	S0	265	37	44.2	52	46.4	26.4	265	205	35	SN5650-PMOKL-0400-20-E0-G0-S0-V04
20°	E0	G0	S1	265	37	44.2	52	46.4	26.4	265	205	35	SN5650-PMOKL-0400-20-E0-G0-S1-V04

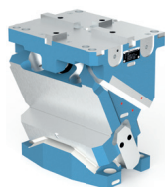

W	E	G	SE	L	W1	s	S1	S2	Sz	L1	L2	L3	No.
20°	E0	G1	S0	265	37	44.2	52	46.4	26.4	265	205	35	SN5650-PMOKL-0400-20-E0-G1-S0-V04
20°	E0	G1	S1	265	37	44.2	52	46.4	26.4	265	205	35	SN5650-PMOKL-0400-20-E0-G1-S1-V04
20°	E1	G0	S0	265	37	44.2	52	46.4	26.4	265	205	35	SN5650-PMOKL-0400-20-E1-G0-S0-V04
20°	E1	G0	S1	265	37	44.2	52	46.4	26.4	265	205	35	SN5650-PMOKL-0400-20-E1-G0-S1-V04
20°	E1	G1	S0	265	37	44.2	52	46.4	26.4	265	205	35	SN5650-PMOKL-0400-20-E1-G1-S0-V04
20°	E1	G1	S1	265	37	44.2	52	46.4	26.4	265	205	35	SN5650-PMOKL-0400-20-E1-G1-S1-V04
25°	E0	G0	S0	265	35	47	52	49.7	26.4	265	205	35	SN5650-PMOKL-0400-25-E0-G0-S0-V04
25°	E0	G0	S1	265	35	47	52	49.7	26.4	265	205	35	SN5650-PMOKL-0400-25-E0-G0-S1-V04
25°	E0	G1	S0	265	35	47	52	49.7	26.4	265	205	35	SN5650-PMOKL-0400-25-E0-G1-S0-V04
25°	E0	G1	S1	265	35	47	52	49.7	26.4	265	205	35	SN5650-PMOKL-0400-25-E0-G1-S1-V04
25°	E1	G0	S0	265	35	47	52	49.7	26.4	265	205	35	SN5650-PMOKL-0400-25-E1-G0-S0-V04
25°	E1	G0	S1	265	35	47	52	49.7	26.4	265	205	35	SN5650-PMOKL-0400-25-E1-G0-S1-V04
25°	E1	G1	S0	265	35	47	52	49.7	26.4	265	205	35	SN5650-PMOKL-0400-25-E1-G1-S0-V04
25°	E1	G1	S1	265	35	47	52	49.7	26.4	265	205	35	SN5650-PMOKL-0400-25-E1-G1-S1-V04
30°	E0	G0	S0	285	32	50.9	52	53	36.4	285	190	40	SN5650-PMOKL-0400-30-E0-G0-S0-V04
30°	E0	G0	S1	285	32	50.9	52	53	36.4	285	190	40	SN5650-PMOKL-0400-30-E0-G0-S1-V04
30°	E0	G1	S0	285	32	50.9	52	53	36.4	285	190	40	SN5650-PMOKL-0400-30-E0-G1-S0-V04
30°	E0	G1	S1	285	32	50.9	52	53	36.4	285	190	40	SN5650-PMOKL-0400-30-E0-G1-S1-V04
30°	E1	G0	S0	285	32	50.9	52	53	36.4	285	190	40	SN5650-PMOKL-0400-30-E1-G0-S0-V04
30°	E1	G0	S1	285	32	50.9	52	53	36.4	285	190	40	SN5650-PMOKL-0400-30-E1-G0-S1-V04
30°	E1	G1	S0	285	32	50.9	52	53	36.4	285	190	40	SN5650-PMOKL-0400-30-E1-G1-S0-V04
30°	E1	G1	S1	285	32	50.9	52	53	36.4	285	190	40	SN5650-PMOKL-0400-30-E1-G1-S1-V04
35°	E0	G0	S0	285	30	49.7	47	52	36.4	285	190	40	SN5650-PMOKL-0400-35-E0-G0-S0-V04
35°	E0	G0	S1	285	30	49.7	47	52	36.4	285	190	40	SN5650-PMOKL-0400-35-E0-G0-S1-V04
35°	E0	G1	S0	285	30	49.7	47	52	36.4	285	190	40	SN5650-PMOKL-0400-35-E0-G1-S0-V04
35°	E0	G1	S1	285	30	49.7	47	52	36.4	285	190	40	SN5650-PMOKL-0400-35-E0-G1-S1-V04
35°	E1	G0	S0	285	30	49.7	47	52	36.4	285	190	40	SN5650-PMOKL-0400-35-E1-G0-S0-V04
35°	E1	G0	S1	285	30	49.7	47	52	36.4	285	190	40	SN5650-PMOKL-0400-35-E1-G0-S1-V04
35°	E1	G1	S0	285	30	49.7	47	52	36.4	285	190	40	SN5650-PMOKL-0400-35-E1-G1-S0-V04
35°	E1	G1	S1	285	30	49.7	47	52	36.4	285	190	40	SN5650-PMOKL-0400-35-E1-G1-S1-V04
40°	E0	G0	S0	285	27	54.7	47	56.5	41.4	285	180	10	SN5650-PMOKL-0400-40-E0-G0-S0-V04
40°	E0	G0	S1	285	27	54.7	47	56.5	41.4	285	180	10	SN5650-PMOKL-0400-40-E0-G0-S1-V04
40°	E0	G1	S0	285	27	54.7	47	56.5	41.4	285	180	10	SN5650-PMOKL-0400-40-E0-G1-S0-V04
40°	E0	G1	S1	285	27	54.7	47	56.5	41.4	285	180	10	SN5650-PMOKL-0400-40-E0-G1-S1-V04
40°	E1	G0	S0	285	27	54.7	47	56.5	41.4	285	180	10	SN5650-PMOKL-0400-40-E1-G0-S0-V04
40°	E1	G0	S1	285	27	54.7	47	56.5	41.4	285	180	10	SN5650-PMOKL-0400-40-E1-G0-S1-V04
40°	E1	G1	S0	285	27	54.7	47	56.5	41.4	285	180	10	SN5650-PMOKL-0400-40-E1-G1-S0-V04
40°	E1	G1	S1	285	27	54.7	47	56.5	41.4	285	180	10	SN5650-PMOKL-0400-40-E1-G1-S1-V04
45°	E0	G0	S0	285	25	60.2	47	62.5	41.4	285	180	10	SN5650-PMOKL-0400-45-E0-G0-S0-V04
45°	E0	G0	S1	285	25	60.2	47	62.5	41.4	285	180	10	SN5650-PMOKL-0400-45-E0-G0-S1-V04
45°	E0	G1	S0	285	25	60.2	47	62.5	41.4	285	180	10	SN5650-PMOKL-0400-45-E0-G1-S0-V04
45°	E0	G1	S1	285	25	60.2	47	62.5	41.4	285	180	10	SN5650-PMOKL-0400-45-E0-G1-S1-V04
45°	E1	G0	S0	285	25	60.2	47	62.5	41.4	285	180	10	SN5650-PMOKL-0400-45-E1-G0-S0-V04
45°	E1	G0	S1	285	25	60.2	47	62.5	41.4	285	180	10	SN5650-PMOKL-0400-45-E1-G0-S1-V04
45°	E1	G1	S0	285	25	60.2	47	62.5	41.4	285	180	10	SN5650-PMOKL-0400-45-E1-G1-S0-V04
45°	E1	G1	S1	285	25	60.2	47	62.5	41.4	285	180	10	SN5650-PMOKL-0400-45-E1-G1-S1-V04
50°	E0	G0	S0	290	22	67.8	47	69.5	46.4	290	165	0	SN5650-PMOKL-0400-50-E0-G0-S0-V04
50°	E0	G0	S1	290	22	67.8	47	69.5	46.4	290	165	0	SN5650-PMOKL-0400-50-E0-G0-S1-V04
50°	E0	G1	S0	290	22	67.8	47	69.5	46.4	290	165	0	SN5650-PMOKL-0400-50-E0-G1-S0-V04
50°	E0	G1	S1	290	22	67.8	47	69.5	46.4	290	165	0	SN5650-PMOKL-0400-50-E0-G1-S1-V04
50°	E1	G0	S0	290	22	67.8	47	69.5	46.4	290	165	0	SN5650-PMOKL-0400-50-E1-G0-S0-V04
50°	E1	G0	S1	290	22	67.8	47	69.5	46.4	290	165	0	SN5650-PMOKL-0400-50-E1-G0-S1-V04
50°	E1	G1	S0	290	22	67.8	47	69.5	46.4	290	165	0	SN5650-PMOKL-0400-50-E1-G1-S0-V04
50°	E1	G1	S1	290	22	67.8	47	69.5	46.4	290	165	0	SN5650-PMOKL-0400-50-E1-G1-S1-V04
55°	E0	G0	S0	290	20	68.8	42	70.7	46.4	290	165	0	SN5650-PMOKL-0400-55-E0-G0-S0-V04

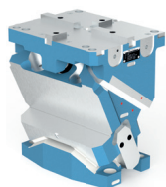

W	E	G	SE	L	W1	s	S1	S2	Sz	L1	L2	L3	No.
55°	E0	G0	S1	290	20	68.8	42	70.7	46.4	290	165	0	SN5650-PMOKL-0400-55-E0-G0-S1-V04
55°	E0	G1	S0	290	20	68.8	42	70.7	46.4	290	165	0	SN5650-PMOKL-0400-55-E0-G1-S0-V04
55°	E0	G1	S1	290	20	68.8	42	70.7	46.4	290	165	0	SN5650-PMOKL-0400-55-E0-G1-S1-V04
55°	E1	G0	S0	290	20	68.8	42	70.7	46.4	290	165	0	SN5650-PMOKL-0400-55-E1-G0-S0-V04
55°	E1	G0	S1	290	20	68.8	42	70.7	46.4	290	165	0	SN5650-PMOKL-0400-55-E1-G0-S1-V04
55°	E1	G1	S0	290	20	68.8	42	70.7	46.4	290	165	0	SN5650-PMOKL-0400-55-E1-G1-S0-V04
55°	E1	G1	S1	290	20	68.8	42	70.7	46.4	290	165	0	SN5650-PMOKL-0400-55-E1-G1-S1-V04
60°	E0	G0	S0	315	17	70.8	37	72.1	46.4	290	145	25	SN5650-PMOKL-0400-60-E0-G0-S0-V04
60°	E0	G0	S1	315	17	70.8	37	72.1	46.4	290	145	25	SN5650-PMOKL-0400-60-E0-G0-S1-V04
60°	E0	G1	S0	315	17	70.8	37	72.1	46.4	290	145	25	SN5650-PMOKL-0400-60-E0-G1-S0-V04
60°	E0	G1	S1	315	17	70.8	37	72.1	46.4	290	145	25	SN5650-PMOKL-0400-60-E0-G1-S1-V04
60°	E1	G0	S0	315	17	70.8	37	72.1	46.4	290	145	25	SN5650-PMOKL-0400-60-E1-G0-S0-V04
60°	E1	G0	S1	315	17	70.8	37	72.1	46.4	290	145	25	SN5650-PMOKL-0400-60-E1-G0-S1-V04
60°	E1	G1	S0	315	17	70.8	37	72.1	46.4	290	145	25	SN5650-PMOKL-0400-60-E1-G1-S0-V04
60°	E1	G1	S1	315	17	70.8	37	72.1	46.4	290	145	25	SN5650-PMOKL-0400-60-E1-G1-S1-V04
65°	E0	G0	S0	315	15	73.1	32	74.6	46.4	290	145	25	SN5650-PMOKL-0400-65-E0-G0-S0-V04
65°	E0	G0	S1	315	15	73.1	32	74.6	46.4	290	145	25	SN5650-PMOKL-0400-65-E0-G0-S1-V04
65°	E0	G1	S0	315	15	73.1	32	74.6	46.4	290	145	25	SN5650-PMOKL-0400-65-E0-G1-S0-V04
65°	E0	G1	S1	315	15	73.1	32	74.6	46.4	290	145	25	SN5650-PMOKL-0400-65-E0-G1-S1-V04
65°	E1	G0	S0	315	15	73.1	32	74.6	46.4	290	145	25	SN5650-PMOKL-0400-65-E1-G0-S0-V04
65°	E1	G0	S1	315	15	73.1	32	74.6	46.4	290	145	25	SN5650-PMOKL-0400-65-E1-G0-S1-V04
65°	E1	G1	S0	315	15	73.1	32	74.6	46.4	290	145	25	SN5650-PMOKL-0400-65-E1-G1-S0-V04
65°	E1	G1	S1	315	15	73.1	32	74.6	46.4	290	145	25	SN5650-PMOKL-0400-65-E1-G1-S1-V04

# SN5650-PMOKL-0400-

## Bauteile Components

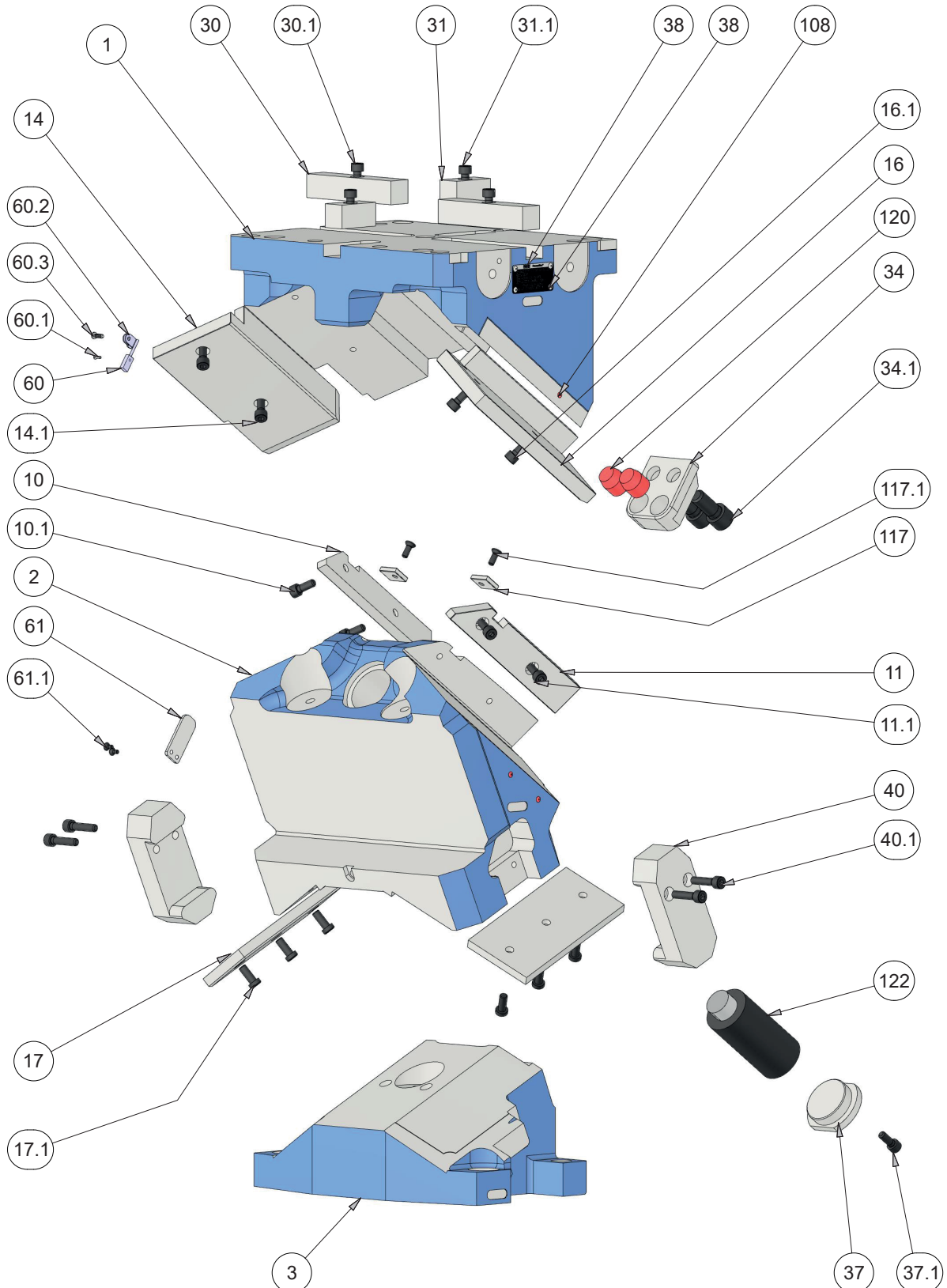

## SN5650-PMOKL-0400-

### Kraftverteilung Force Distribution

#### 500.000 Stroke

W	FS [kN]	FP [kN]	Fh1 [kN]	FW [kN]	Fh2 [kN]	h1 [mm]	h2 [mm]	FA [kN]
00°	964	912	964	912	0	150	50	54
05°	1064	994	981	901	79	145	65	59
10°	1070	1021	907	835	174	140	80	66
15°	1088	1028	851	747	200	140	80	71
20°	1114	1071	796	690	251	125	75	77
25°	1151	1098	758	612	285	125	75	75
30°	1174	1137	699	550	317	110	100	75
35°	1206	1161	660	469	328	110	100	75
40°	1225	1193	598	406	341	125	120	88
45°	1251	1213	556	329	329	125	120	65
50°	1266	1240	491	271	323	140	140	56
55°	1287	1258	448	203	290	140	140	55
60°	1298	1279	381	155	268	150	165	48
65°	1160	1142	296	90	194	150	165	47

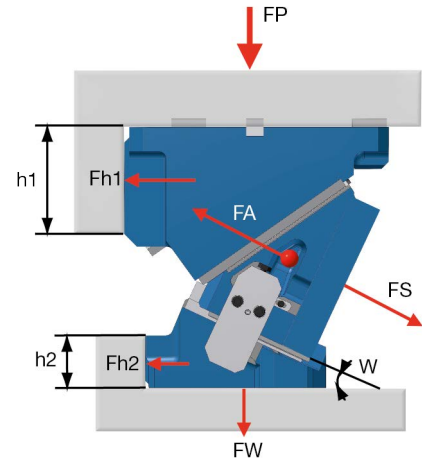

#### 1.000.000 Stroke

W	FS [kN]	FP [kN]	Fh1 [kN]	FW [kN]	Fh2 [kN]	h1 [mm]	h2 [mm]	FA [kN]
00°	723	687	723	687	0	150	50	54
05°	798	749	736	679	59	145	65	59
10°	803	768	679	629	111	140	80	66
15°	816	774	637	563	151	140	80	71
20°	836	806	596	520	189	125	75	77
25°	863	826	567	461	215	125	75	75
30°	881	855	523	414	239	110	100	75
35°	905	873	493	354	248	110	100	75
40°	919	897	447	306	257	125	120	88
45°	938	912	415	248	248	125	120	65
50°	950	932	367	205	244	140	140	56
55°	965	944	334	154	220	140	140	55
60°	974	960	284	117	203	150	165	48
65°	870	857	220	69	147	150	165	47

W = Schieberwinkel

FP = P-Press

FW = W-Werkzeug

ES = S-Schieberkraft

FA = A-Abstreifkraft

Fh1 = h1-Abschulterung oben

Fh2 = h2-Abschulterung unten

W = Cam Angle

FP = P-Press

FW = W-Tool

ES = S-Cam Force

FA = A-Retractility

Fh1 = h1-Shouldering above

Fh2 = h2-Shouldering below

## SN5650-PMOKL-0400-

### Schieberkräfte

#### Cam Force

Abschulterung

Shouldering

Passfeder

Fitting Key

#### SN5650-PMOKL-0400-0°

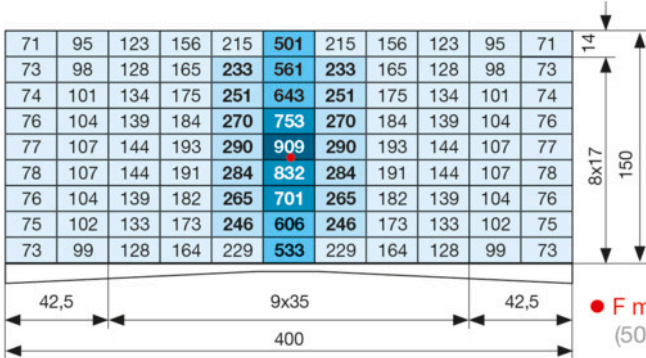

71	95	106	118	134	156	134	118	106	95	71
73	95	105	118	134	156	134	118	105	95	73
74	95	105	118	134	156	134	118	105	95	74
76	95	105	118	134	156	134	118	105	95	76
77	95	105	118	134	156	134	118	105	95	77
78	95	105	118	134	156	134	118	105	95	78
76	95	105	118	134	156	134	118	105	95	76
75	95	105	118	134	156	134	118	105	95	75
73	95	105	118	134	150	134	118	105	95	73

#### SN5650-PMOKL-0400-5°

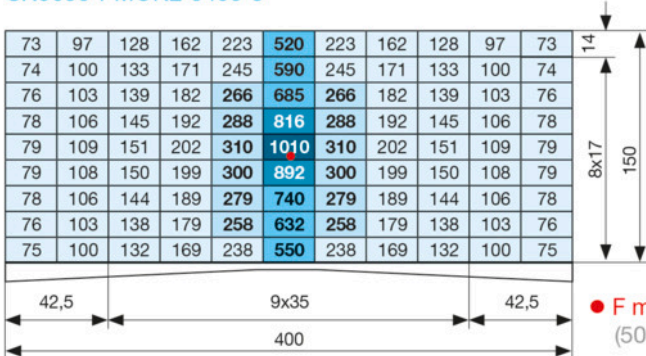

73	97	112	127	145	170	145	127	112	97	73
74	99	112	126	145	170	145	126	112	99	74
76	99	112	126	145	170	145	126	112	99	76
78	99	112	126	145	170	145	126	112	99	78
79	99	112	126	145	170	145	126	112	99	79
79	99	112	126	145	170	145	126	112	99	79
78	99	112	126	145	170	145	126	112	99	78
76	99	112	126	145	170	145	126	112	99	76
75	99	112	126	145	170	145	126	112	99	75

#### SN5650-PMOKL-0400-10°

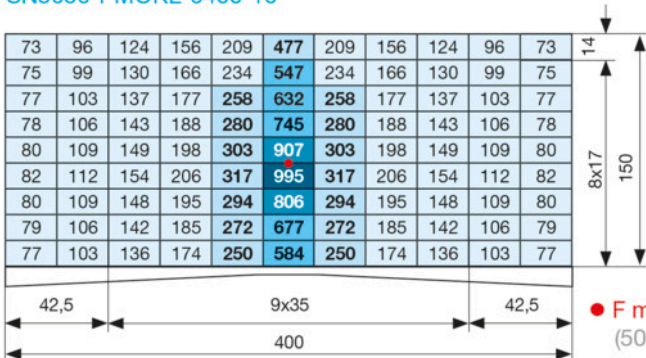

73	96	120	137	157	186	157	137	120	96	73
75	99	120	136	157	186	157	136	120	99	75
77	103	120	136	157	186	157	136	120	103	77
78	104	120	136	157	186	157	136	120	104	78
80	104	120	136	157	186	157	136	120	104	80
82	104	120	136	157	186	157	136	120	104	82
80	104	120	136	157	186	157	136	120	104	80
79	104	120	136	157	186	157	136	120	104	79
77	103	120	136	157	186	157	136	120	103	77

#### SN5650-PMOKL-0400-15°

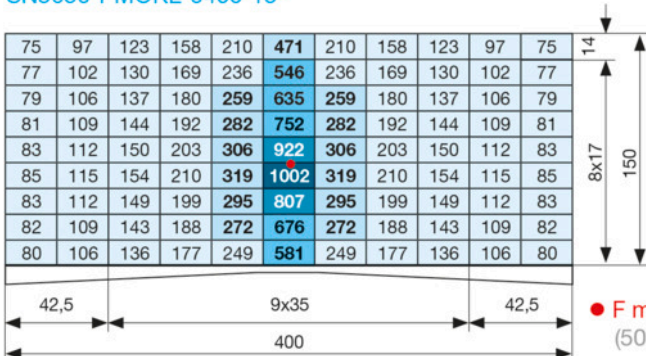

75	97	123	147	170	202	170	147	123	97	75
77	102	127	146	169	202	169	146	127	102	77
79	106	127	145	169	202	169	145	127	106	79
81	109	127	145	169	202	169	145	127	109	81
83	109	127	145	169	202	169	145	127	109	83
85	109	127	145	169	202	169	145	127	109	85
83	109	127	145	169	202	169	145	127	109	83
82	109	127	145	169	202	169	145	127	109	82
80	106	127	145	169	202	169	145	127	106	80

## SN5650-PMOKL-0400-

### Schieberkräfte

#### Cam Force

Abschulterung

Shouldering

Passfeder

Fitting Key

#### SN5650-PMOKL-0400-20°

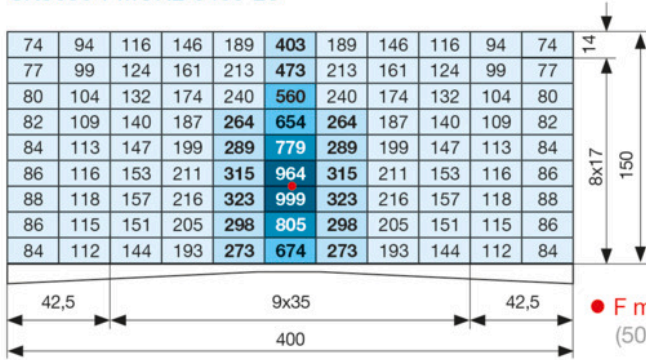

74	94	116	146	<b>186</b>	<b>222</b>	<b>186</b>	146	116	94	74
77	99	124	159	<b>185</b>	<b>222</b>	<b>185</b>	159	124	99	77
80	104	132	158	<b>184</b>	<b>222</b>	<b>184</b>	158	132	104	80
82	109	135	157	<b>184</b>	<b>222</b>	<b>184</b>	157	135	109	82
84	113	135	157	<b>184</b>	<b>222</b>	<b>184</b>	157	135	113	84
86	116	135	157	<b>184</b>	<b>222</b>	<b>184</b>	157	135	116	86
88	116	135	157	<b>184</b>	<b>222</b>	<b>184</b>	157	135	116	88
86	115	135	157	<b>184</b>	<b>222</b>	<b>184</b>	157	135	115	86
84	112	135	157	<b>184</b>	<b>222</b>	<b>184</b>	157	135	112	84

#### SN5650-PMOKL-0400-25°

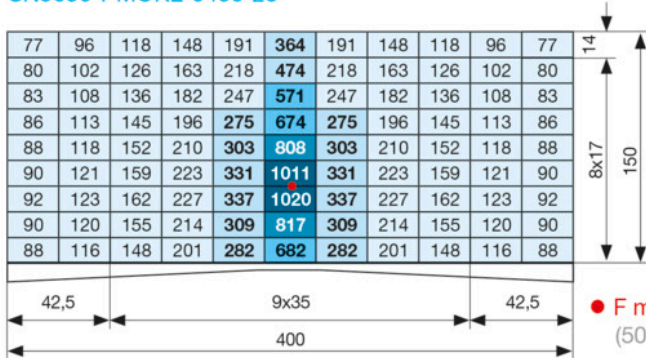

77	96	118	148	191	<b>242</b>	191	148	118	96	77
80	102	126	163	200	<b>242</b>	200	163	126	102	80
83	108	136	170	199	<b>242</b>	199	170	136	108	83
86	113	142	169	199	<b>242</b>	199	169	142	113	86
88	118	142	169	199	<b>242</b>	199	169	142	118	88
90	121	142	169	199	<b>242</b>	199	169	142	121	90
92	122	142	169	199	<b>242</b>	199	169	142	122	92
90	120	142	169	199	<b>242</b>	199	169	142	120	90
88	116	142	169	199	<b>242</b>	199	169	142	116	88

#### SN5650-PMOKL-0400-30°

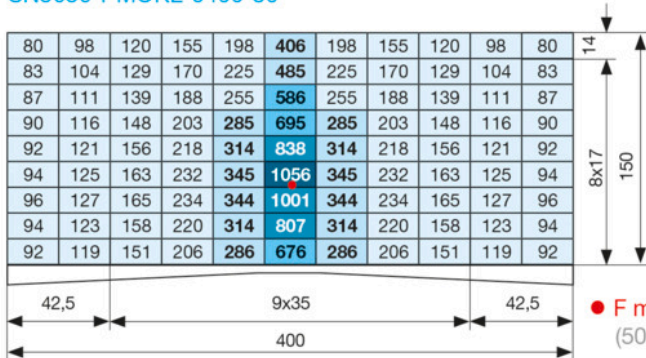

80	98	120	155	198	<b>268</b>	198	155	120	98	80
83	104	129	170	220	<b>268</b>	220	170	129	104	83
87	111	139	185	219	<b>268</b>	219	185	139	111	87
90	116	148	185	219	<b>268</b>	219	185	148	116	90
92	121	153	185	219	<b>268</b>	219	185	153	121	92
94	125	153	185	219	<b>268</b>	219	185	153	125	94
96	127	153	185	219	<b>268</b>	219	185	153	127	96
94	123	153	185	219	<b>268</b>	219	185	153	123	94
92	119	151	185	219	<b>268</b>	219	185	151	119	92

#### SN5650-PMOKL-0400-35°

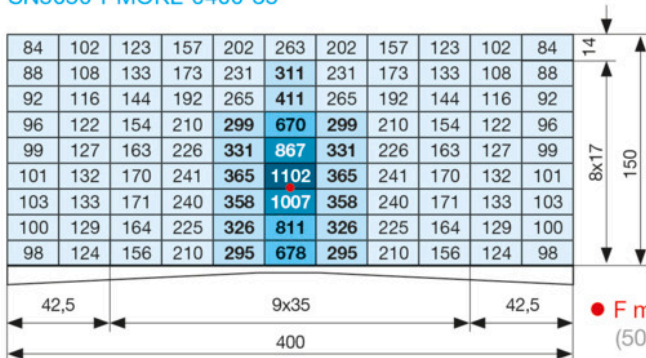

84	102	123	157	202	263	202	157	123	102	84
88	108	133	173	231	<b>293</b>	231	173	133	108	88
92	116	144	192	238	<b>293</b>	238	192	144	116	92
96	122	154	198	238	<b>293</b>	238	198	154	122	96
99	127	163	198	238	<b>293</b>	238	198	163	127	99
101	132	164	198	238	<b>293</b>	238	198	164	132	101
103	133	164	198	238	<b>293</b>	238	198	164	133	103
100	129	164	198	238	<b>293</b>	238	198	164	129	100
98	124	156	198	238	<b>293</b>	238	198	156	124	98

# SN5650-PMOKL-0400-

## Schieberkräfte

### Cam Force

Abschulterung

Shouldering

Passfeder

Fitting Key

#### SN5650-PMOKL-0400-40°

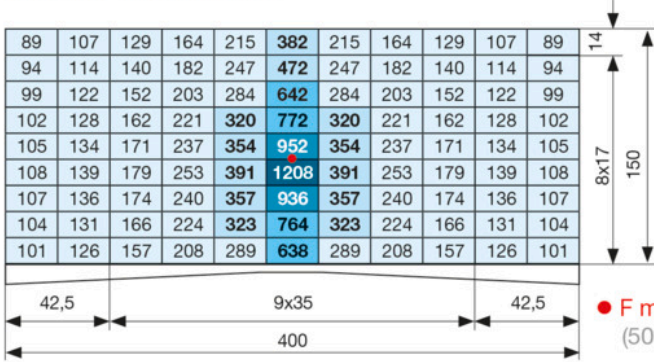

89	107	129	164	215	<b>329</b>	<b>215</b>	164	129	107	89
94	114	140	182	247	<b>329</b>	<b>247</b>	182	140	114	94
99	122	152	<b>203</b>	<b>265</b>	<b>329</b>	<b>265</b>	203	152	122	99
102	128	162	<b>217</b>	<b>265</b>	<b>329</b>	<b>265</b>	217	162	128	102
105	134	171	<b>217</b>	<b>265</b>	<b>329</b>	<b>265</b>	217	171	134	105
108	139	179	<b>217</b>	<b>265</b>	<b>329</b>	<b>265</b>	217	179	139	108
107	136	174	<b>217</b>	<b>265</b>	<b>329</b>	<b>265</b>	217	174	136	107
104	131	166	<b>217</b>	<b>265</b>	<b>329</b>	<b>265</b>	217	166	131	104
101	126	157	<b>208</b>	<b>265</b>	<b>329</b>	<b>265</b>	208	157	126	101

#### SN5650-PMOKL-0400-45°

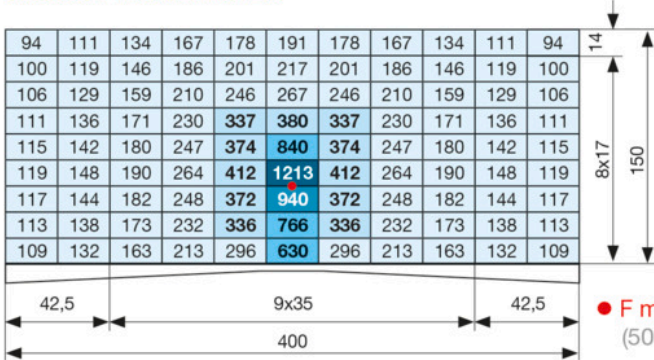

94	111	134	167	178	191	178	167	134	111	94
100	119	146	186	201	217	201	186	146	119	100
106	129	159	210	246	267	246	210	159	129	106
111	136	171	230	<b>291</b>	<b>362</b>	<b>291</b>	230	171	136	111
115	142	180	247	<b>235</b>	<b>291</b>	<b>235</b>	247	180	142	115
119	148	190	264	<b>235</b>	<b>291</b>	<b>235</b>	264	190	148	119
117	144	182	248	<b>235</b>	<b>291</b>	<b>235</b>	248	182	144	117
113	138	173	232	<b>291</b>	<b>362</b>	<b>291</b>	232	173	138	113
109	132	163	213	291	<b>362</b>	<b>291</b>	213	163	132	109

#### SN5650-PMOKL-0400-50°

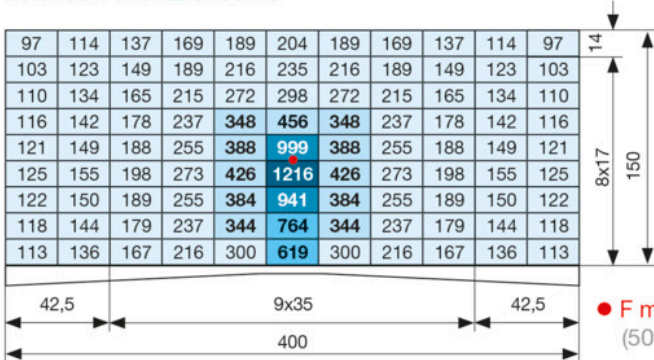

97	114	<b>137</b>	<b>169</b>	<b>189</b>	<b>204</b>	<b>189</b>	<b>169</b>	<b>137</b>	114	97
103	123	<b>149</b>	<b>189</b>	<b>216</b>	<b>235</b>	<b>216</b>	<b>189</b>	<b>149</b>	123	103
110	<b>134</b>	<b>165</b>	<b>215</b>	<b>272</b>	<b>298</b>	<b>272</b>	<b>215</b>	<b>165</b>	<b>134</b>	110
116	<b>142</b>	<b>178</b>	<b>237</b>	<b>331</b>	<b>414</b>	<b>331</b>	<b>237</b>	<b>178</b>	<b>142</b>	116
121	<b>149</b>	<b>188</b>	<b>255</b>	<b>331</b>	<b>414</b>	<b>331</b>	<b>255</b>	<b>188</b>	<b>149</b>	121
125	<b>155</b>	<b>198</b>	<b>263</b>	<b>331</b>	<b>414</b>	<b>331</b>	<b>263</b>	<b>198</b>	<b>155</b>	125
122	<b>150</b>	<b>189</b>	<b>255</b>	<b>331</b>	<b>414</b>	<b>331</b>	<b>255</b>	<b>189</b>	<b>150</b>	122
118	<b>144</b>	<b>179</b>	<b>237</b>	<b>331</b>	<b>414</b>	<b>331</b>	<b>237</b>	<b>179</b>	<b>144</b>	118
113	<b>136</b>	<b>167</b>	<b>216</b>	<b>300</b>	<b>414</b>	<b>300</b>	<b>216</b>	<b>167</b>	<b>136</b>	113

#### SN5650-PMOKL-0400-55°

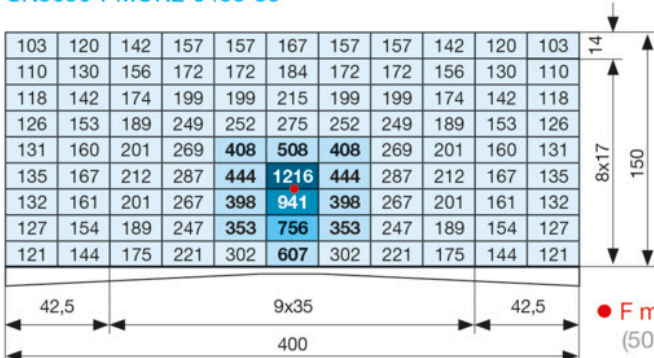

103	120	<b>142</b>	<b>157</b>	<b>157</b>	<b>167</b>	<b>157</b>	<b>157</b>	<b>142</b>	120	103
110	130	<b>156</b>	<b>172</b>	<b>172</b>	<b>184</b>	<b>172</b>	<b>172</b>	<b>156</b>	<b>130</b>	110
118	<b>142</b>	<b>174</b>	<b>199</b>	<b>199</b>	<b>215</b>	<b>199</b>	<b>199</b>	<b>174</b>	<b>142</b>	118
126	<b>153</b>	<b>189</b>	<b>249</b>	<b>252</b>	<b>275</b>	<b>252</b>	<b>249</b>	<b>189</b>	<b>153</b>	126
131	<b>160</b>	<b>201</b>	<b>269</b>	<b>369</b>	<b>462</b>	<b>369</b>	<b>269</b>	<b>201</b>	<b>160</b>	131
135	<b>167</b>	<b>212</b>	<b>287</b>	<b>369</b>	<b>462</b>	<b>369</b>	<b>287</b>	<b>212</b>	<b>167</b>	135
132	<b>161</b>	<b>201</b>	<b>267</b>	<b>369</b>	<b>462</b>	<b>369</b>	<b>267</b>	<b>201</b>	<b>161</b>	132
127	<b>154</b>	<b>189</b>	<b>247</b>	<b>353</b>	<b>462</b>	<b>353</b>	<b>247</b>	<b>189</b>	<b>154</b>	127
121	<b>144</b>	<b>175</b>	<b>221</b>	<b>302</b>	<b>462</b>	<b>302</b>	<b>221</b>	<b>175</b>	<b>144</b>	121

# SN5650-PMOKL-0400-

## Schieberkräfte

### Cam Force

Abschulterung

Shouldering

Passfeder

Fitting Key

#### SN5650-PMOKL-0400-60°

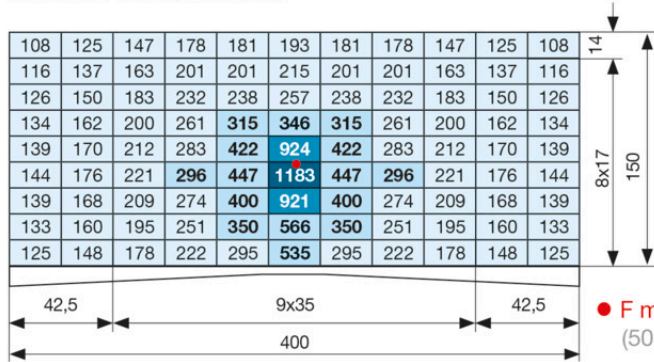

108	125	147	178	181	193	181	178	147	125	108
116	137	163	201	201	215	201	201	163	137	116
126	150	183	232	238	257	238	232	183	150	126
134	162	200	261	315	346	315	261	200	162	134
139	170	212	283	422	547	422	283	212	170	139
144	176	221	296	430	547	430	296	221	176	144
139	168	209	274	400	547	400	274	209	168	139
133	160	195	251	350	547	350	251	195	160	133
125	148	178	222	295	535	295	222	178	148	125

#### SN5650-PMOKL-0400-65°

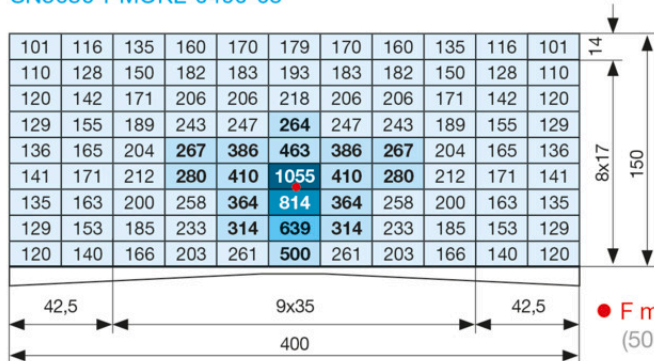

101	116	135	160	170	179	170	160	135	116	101
110	128	150	182	183	193	183	182	150	128	110
120	142	171	206	206	218	206	206	171	142	120
129	155	189	243	247	264	247	243	189	155	129
136	165	204	267	386	463	386	267	204	165	136
141	171	212	280	410	625	410	280	212	171	141
135	163	200	258	364	625	364	258	200	163	135
129	153	185	233	314	625	314	233	185	153	129
120	140	166	203	261	500	261	203	166	140	120

# SN5650-PMOKL-0400-

## Schieberkräfte

### Cam Force

Abschulterung

Shouldering

Passfeder

Fitting Key

#### SN5650-PMOKL-0400-0°



53	71	80	89	101	<b>117</b>	101	89	80	71	53
55	71	79	89	101	<b>117</b>	101	89	79	71	55
56	71	79	89	101	<b>117</b>	101	89	79	71	56
57	71	79	89	101	<b>117</b>	101	89	79	71	57
58	71	79	89	101	<b>117</b>	101	89	79	71	58
59	71	79	89	101	<b>117</b>	101	89	79	71	59
57	71	79	89	101	<b>117</b>	101	89	79	71	57
56	71	79	89	101	<b>117</b>	101	89	79	71	56
55	71	79	89	101	<b>113</b>	101	89	79	71	55

#### SN5650-PMOKL-0400-5°

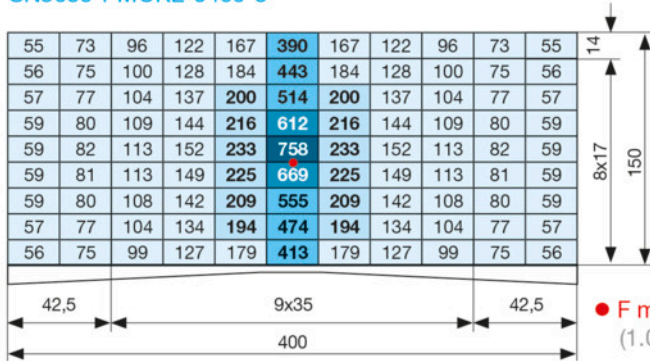

55	73	84	95	109	<b>128</b>	109	95	84	73	55
56	74	84	95	109	<b>128</b>	109	95	84	74	56
57	74	84	95	109	<b>128</b>	109	95	84	74	57
59	74	84	95	109	<b>128</b>	109	95	84	74	59
59	74	84	95	109	<b>128</b>	109	95	84	74	59
59	74	84	95	109	<b>128</b>	109	95	84	74	59
59	74	84	95	109	<b>128</b>	109	95	84	74	59
57	74	84	95	109	<b>128</b>	109	95	84	74	57
56	74	84	95	109	<b>128</b>	109	95	84	74	56

#### SN5650-PMOKL-0400-10°

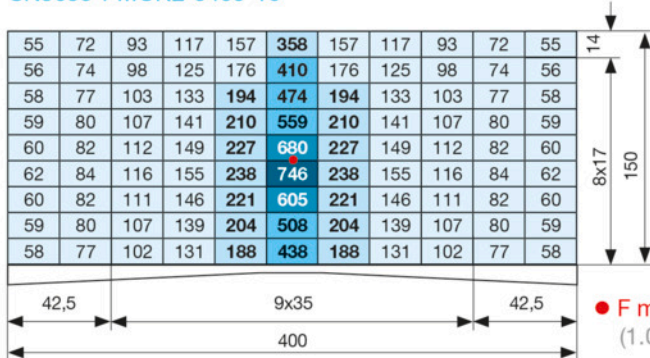

55	72	90	103	118	<b>140</b>	118	103	90	72	55
56	74	90	102	118	<b>140</b>	118	102	90	74	56
58	77	90	102	118	<b>140</b>	118	102	90	77	58
59	78	90	102	118	<b>140</b>	118	102	90	78	59
60	78	90	102	118	<b>140</b>	118	102	90	78	60
62	78	90	102	118	<b>140</b>	118	102	90	78	62
60	78	90	102	118	<b>140</b>	118	102	90	78	60
59	78	90	102	118	<b>140</b>	118	102	90	78	59
58	77	90	102	118	<b>140</b>	118	102	90	77	58

#### SN5650-PMOKL-0400-15°

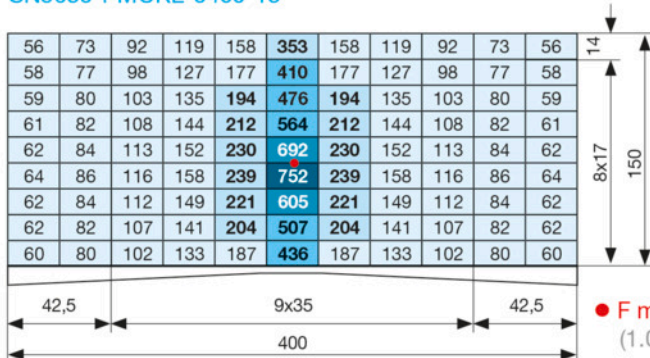

56	73	92	110	128	<b>152</b>	128	110	92	73	56
58	77	95	110	127	<b>152</b>	127	110	95	77	58
59	80	95	109	127	<b>152</b>	127	109	95	80	59
61	82	95	109	127	<b>152</b>	127	109	95	82	61
62	82	95	109	127	<b>152</b>	127	109	95	82	62
64	82	95	109	127	<b>152</b>	127	109	95	82	64
62	82	95	109	127	<b>152</b>	127	109	95	82	62
62	82	95	109	127	<b>152</b>	127	109	95	82	62
60	80	95	109	127	<b>152</b>	127	109	95	80	60

# SN5650-PMOKL-0400-

## Schieberkräfte

### Cam Force

Abschulterung

Shouldering

Passfeder

Fitting Key

#### SN5650-PMOKL-0400-20°

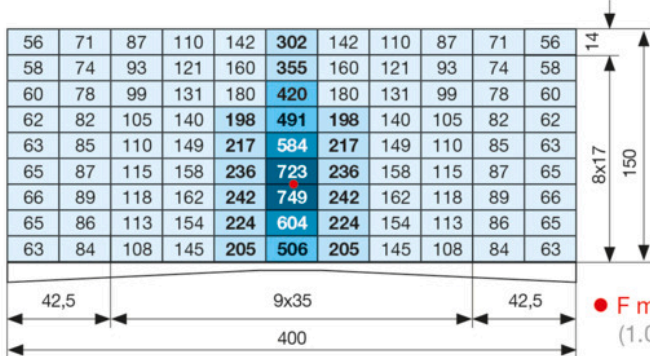

56	71	87	110	<b>140</b>	<b>167</b>	<b>140</b>	110	87	71	56
58	74	93	119	<b>139</b>	<b>167</b>	<b>139</b>	119	93	74	58
60	78	99	119	<b>138</b>	<b>167</b>	<b>138</b>	119	99	78	60
62	82	<b>101</b>	<b>118</b>	<b>138</b>	<b>167</b>	<b>138</b>	<b>118</b>	<b>101</b>	82	62
63	85	<b>101</b>	<b>118</b>	<b>138</b>	<b>167</b>	<b>138</b>	<b>118</b>	<b>101</b>	85	63
65	87	<b>101</b>	<b>118</b>	<b>138</b>	<b>167</b>	<b>138</b>	<b>118</b>	<b>101</b>	87	65
66	87	<b>101</b>	<b>118</b>	<b>138</b>	<b>167</b>	<b>138</b>	<b>118</b>	<b>101</b>	87	66
65	86	<b>101</b>	<b>118</b>	<b>138</b>	<b>167</b>	<b>138</b>	<b>118</b>	<b>101</b>	86	65
63	84	<b>101</b>	<b>118</b>	<b>138</b>	<b>167</b>	<b>138</b>	<b>118</b>	<b>101</b>	84	63

#### SN5650-PMOKL-0400-25°

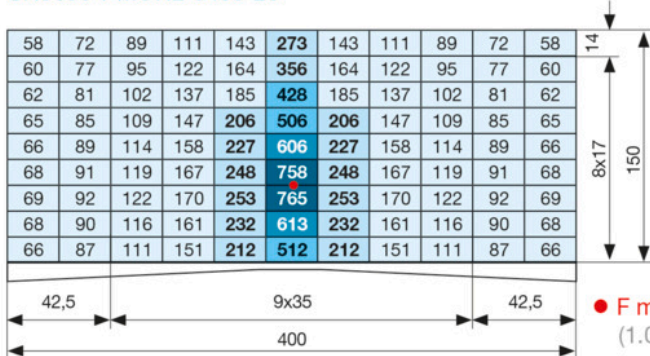

58	72	89	111	<b>143</b>	<b>182</b>	<b>143</b>	111	89	72	58
60	77	95	122	<b>150</b>	<b>182</b>	<b>150</b>	122	95	77	60
62	81	102	128	<b>149</b>	<b>182</b>	<b>149</b>	128	102	81	62
65	85	107	127	<b>149</b>	<b>182</b>	<b>149</b>	127	107	85	65
66	89	107	127	<b>149</b>	<b>182</b>	<b>149</b>	127	107	89	66
68	91	107	127	<b>149</b>	<b>182</b>	<b>149</b>	127	107	91	68
69	92	107	127	<b>149</b>	<b>182</b>	<b>149</b>	127	107	92	69
68	90	107	127	<b>149</b>	<b>182</b>	<b>149</b>	127	107	90	68
66	87	107	127	<b>149</b>	<b>182</b>	<b>149</b>	127	107	87	66

#### SN5650-PMOKL-0400-30°

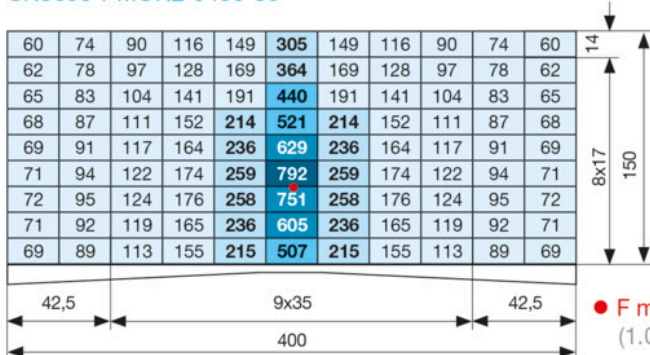

60	74	90	116	<b>149</b>	<b>201</b>	<b>149</b>	116	90	74	60
62	78	97	128	<b>165</b>	<b>201</b>	<b>165</b>	128	97	78	62
65	83	104	139	<b>164</b>	<b>201</b>	<b>164</b>	139	104	83	65
68	87	111	139	<b>164</b>	<b>201</b>	<b>164</b>	139	111	87	68
69	91	115	139	<b>164</b>	<b>201</b>	<b>164</b>	139	115	91	69
71	94	115	139	<b>164</b>	<b>201</b>	<b>164</b>	139	115	94	71
72	95	115	139	<b>164</b>	<b>201</b>	<b>164</b>	139	115	95	72
71	92	115	139	<b>164</b>	<b>201</b>	<b>164</b>	139	115	92	71
69	89	113	139	<b>164</b>	<b>201</b>	<b>164</b>	139	113	89	69

#### SN5650-PMOKL-0400-35°

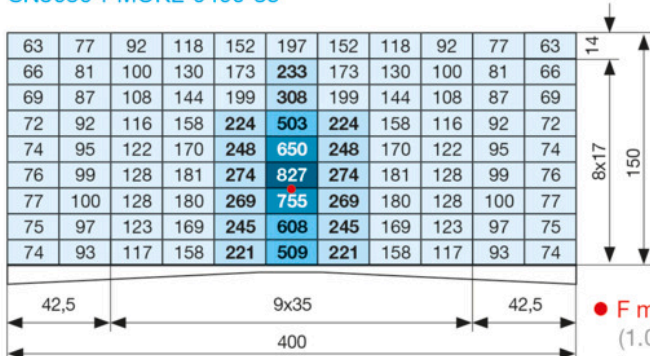

63	77	92	118	<b>152</b>	<b>197</b>	<b>152</b>	118	92	77	63
66	81	100	130	<b>173</b>	<b>220</b>	<b>173</b>	130	100	81	66
69	87	108	144	<b>179</b>	<b>220</b>	<b>179</b>	144	108	87	69
72	92	116	149	<b>179</b>	<b>220</b>	<b>179</b>	149	116	92	72
74	95	122	149	<b>179</b>	<b>220</b>	<b>179</b>	149	122	95	74
76	99	123	149	<b>179</b>	<b>220</b>	<b>179</b>	149	123	99	76
77	100	123	149	<b>179</b>	<b>220</b>	<b>179</b>	149	123	100	77
75	97	123	149	<b>179</b>	<b>220</b>	<b>179</b>	149	123	97	75
74	93	117	149	<b>179</b>	<b>220</b>	<b>179</b>	149	117	93	74

# SN5650-PMOKL-0400-

## Schieberkräfte

### Cam Force

Abschulterung

Shouldering

Passfeder

Fitting Key

#### SN5650-PMOKL-0400-40°

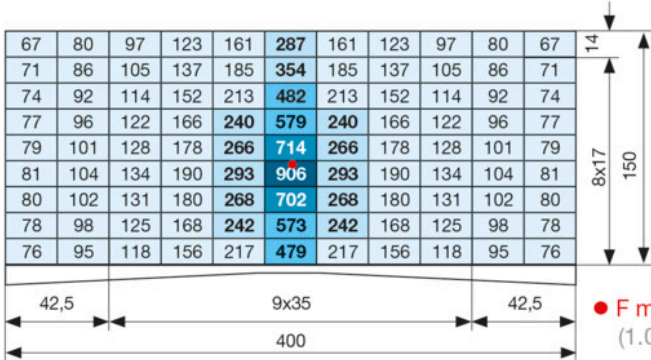

67	80	97	123	161	<b>247</b>	161	123	97	80	67
71	86	105	137	185	<b>247</b>	185	137	105	86	71
74	92	114	152	199	<b>247</b>	199	152	114	92	74
77	96	122	163	199	<b>247</b>	199	163	122	96	77
79	101	128	163	199	<b>247</b>	199	163	128	101	79
81	104	134	163	199	<b>247</b>	199	163	134	104	81
80	102	131	163	199	<b>247</b>	199	163	131	102	80
78	98	125	163	199	<b>247</b>	199	163	125	98	78
76	95	118	156	199	<b>247</b>	199	156	118	95	76

#### SN5650-PMOKL-0400-45°

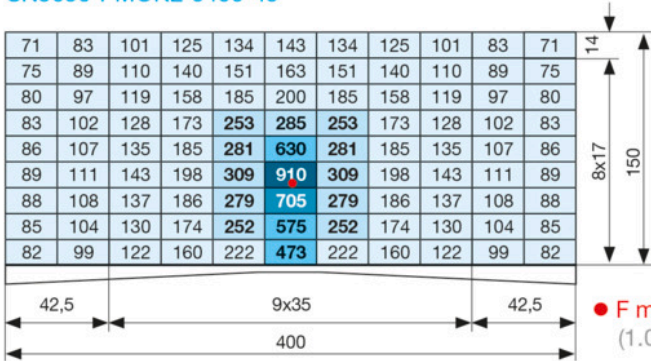

71	83	101	125	134	143	134	125	101	83	71
75	89	110	140	151	163	151	140	110	89	75
80	97	119	158	185	200	185	158	119	97	80
83	102	128	173	218	<b>272</b>	218	173	128	102	83
86	107	135	176	218	<b>272</b>	218	176	135	107	86
89	111	143	176	218	<b>272</b>	218	176	143	111	89
88	108	137	176	218	<b>272</b>	218	176	137	108	88
85	104	130	174	218	<b>272</b>	218	174	130	104	85
82	99	122	160	218	<b>272</b>	218	160	122	99	82

#### SN5650-PMOKL-0400-50°

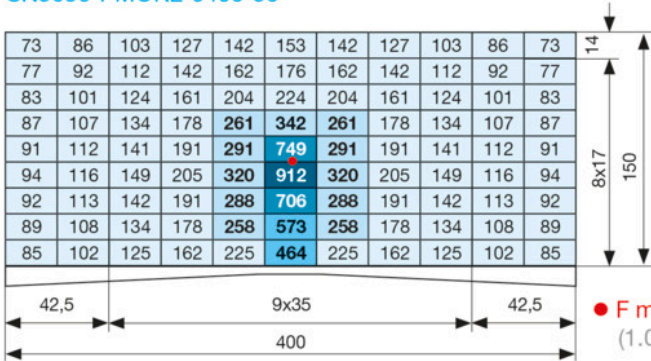

73	86	103	127	142	153	142	127	103	86	73
77	92	112	142	162	176	162	142	112	92	77
83	101	124	161	204	224	204	161	124	101	83
87	107	134	178	248	<b>311</b>	248	178	134	107	87
91	112	141	191	248	<b>311</b>	248	191	141	112	91
94	116	149	197	248	<b>311</b>	248	197	149	116	94
92	113	142	191	248	<b>311</b>	248	191	142	113	92
89	108	134	178	248	<b>311</b>	248	178	134	108	89
85	102	125	162	225	<b>311</b>	225	162	125	102	85

#### SN5650-PMOKL-0400-55°

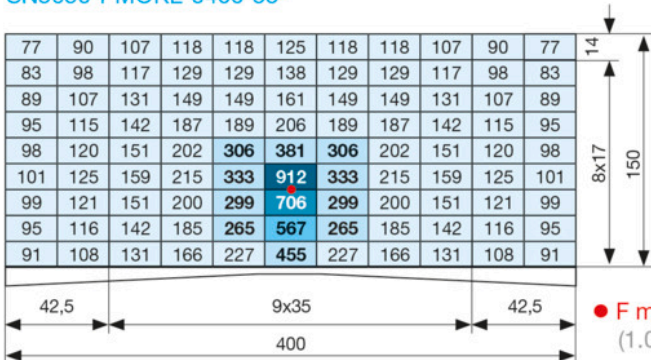

77	90	107	118	118	125	118	118	107	90	77
83	98	117	129	129	138	129	129	117	98	83
89	107	131	149	149	161	149	149	131	107	89
95	115	142	187	189	206	189	187	142	115	95
98	120	151	202	277	<b>347</b>	277	202	151	120	98
101	125	159	215	277	<b>347</b>	277	215	159	125	101
99	121	151	200	277	<b>347</b>	277	200	151	121	99
95	116	142	185	265	<b>347</b>	265	185	142	116	95
91	108	131	166	227	<b>347</b>	227	166	131	108	91

## SN5650-PMOKL-0400-

### Schieberkräfte

#### Cam Force

Abschulterung

Shouldering

Passfeder

Fitting Key

#### SN5650-PMOKL-0400-60°

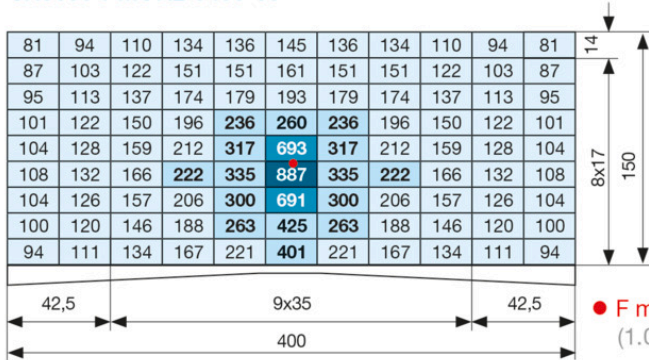

81	94	110	134	136	145	136	134	110	94	81
87	103	122	151	151	161	151	151	122	103	87
95	113	137	174	179	193	179	174	137	113	95
101	122	150	196	236	260	236	196	150	122	101
104	128	159	212	317	410	317	212	159	128	104
108	132	166	222	323	410	323	222	166	132	108
104	126	157	206	300	410	300	206	157	126	104
100	120	146	188	263	410	263	188	146	120	100
94	111	134	167	221	401	221	167	134	111	94

#### SN5650-PMOKL-0400-65°

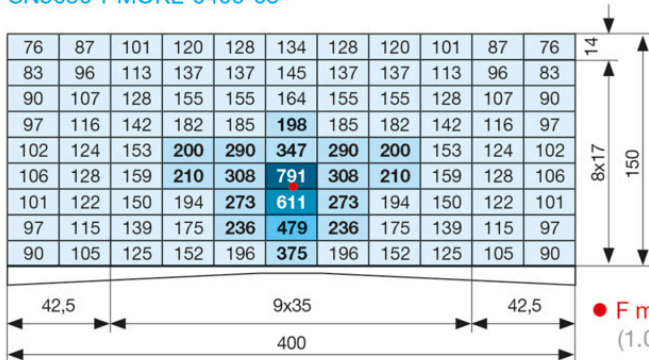

76	87	101	120	128	134	128	120	101	87	76
83	96	113	137	137	145	137	137	113	96	83
90	107	128	155	155	164	155	155	128	107	90
97	116	142	182	185	198	185	182	142	116	97
102	124	153	200	290	347	290	200	153	124	102
106	128	159	210	308	469	308	210	159	128	106
101	122	150	194	273	469	273	194	150	122	101
97	115	139	175	236	469	236	175	139	115	97
90	105	125	152	196	375	196	152	125	105	90