



SN5650-PMO-0180-

Oben hängender Schieber

Aerial cam unit

Arbeitsfläche	<i>Working area</i>	180 x 151 mm
Schieberbreite max.	<i>Cam unit width max.</i>	180 mm
Einbauhöhe	<i>Installation height</i>	300 mm
Schieberkraft	<i>Cam force</i>	> 411 kN

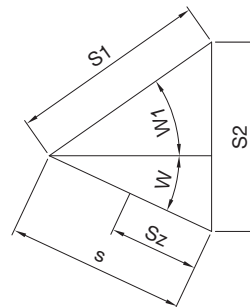
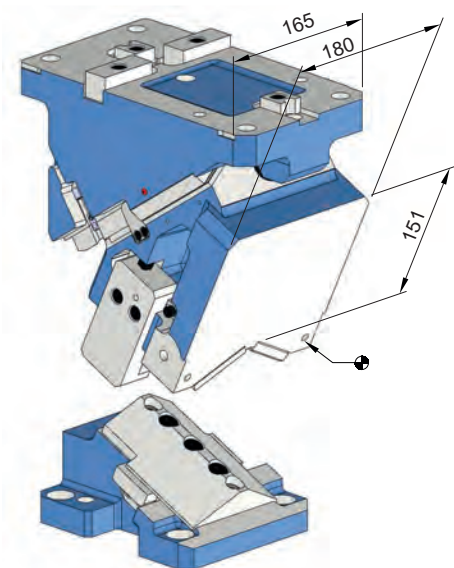
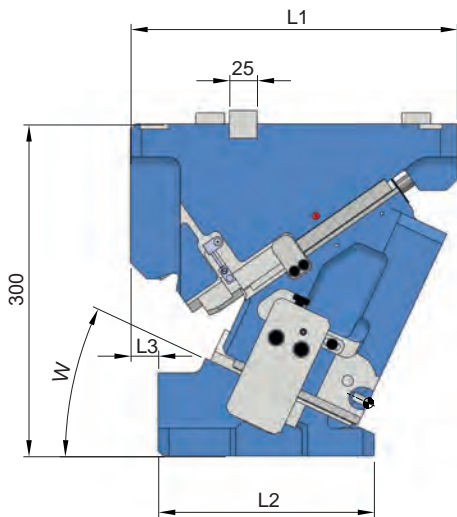

Gusstoleranzgrad CT
nach DIN ISO 8062

(blau = Rohgussfläche)

Casting tolerance grade CT
according to DIN ISO 8062

(blue = raw casting area)

**Positionskontrolle:
Control of position:**



Pos. 1

Schieber zusammengefahren
Cam is moved together



Pos. 2

Schieber ausgefahren
Cam is extended

Sz = Eingriffslänge Aktivrückzug
Sz = Engagement length of activ return

SN5650-PMO-0180-

Oben hängender Schieber

Aerial cam unit

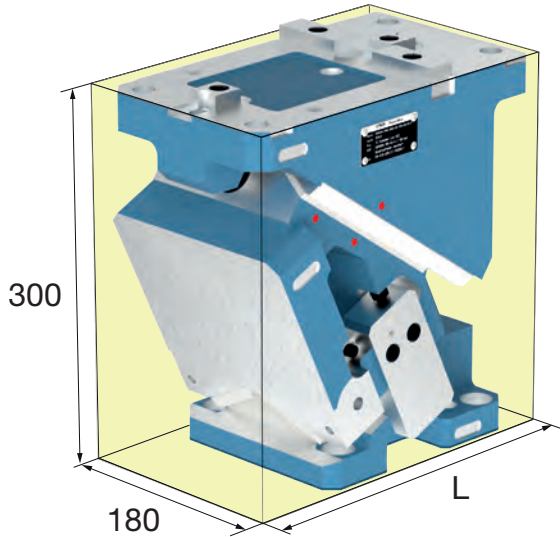

Mat.: EN-GJS-600-3 (GGG 60)

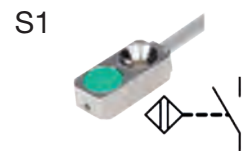

W = Schieberwinkel
Cam Angle

E = Einarbeitung
Machining

G = Gasdruckfeder
Gas spring

SE = Sensor
Sensor

W	E	G	SE	L	W1	s	S1	S2	Sz	L1	L2	L3	No.
0°	E0	G0	S0	280	47	35.5	52	38	16	280	235	40	SN5650-PMO-0180-00-E0-G0-S0-V04
0°	E0	G0	S1	280	47	35.5	52	38	16	280	235	40	SN5650-PMO-0180-00-E0-G0-S1-V04
0°	E0	G1	S0	280	47	35.5	52	38	16	280	235	40	SN5650-PMO-0180-00-E0-G1-S0-V04
0°	E0	G1	S1	280	47	35.5	52	38	16	280	235	40	SN5650-PMO-0180-00-E0-G1-S1-V04
0°	E1	G0	S0	280	47	35.5	52	38	16	280	235	40	SN5650-PMO-0180-00-E1-G0-S0-V04
0°	E1	G0	S1	280	47	35.5	52	38	16	280	235	40	SN5650-PMO-0180-00-E1-G0-S1-V04
0°	E1	G1	S0	280	47	35.5	52	38	16	280	235	40	SN5650-PMO-0180-00-E1-G1-S0-V04
0°	E1	G1	S1	280	47	35.5	52	38	16	280	235	40	SN5650-PMO-0180-00-E1-G1-S1-V04
5°	E0	G0	S0	281	45	36.9	52	40	21	280	235	40	SN5650-PMO-0180-05-E0-G0-S0-V04
5°	E0	G0	S1	281	45	36.9	52	40	21	280	235	40	SN5650-PMO-0180-05-E0-G0-S1-V04
5°	E0	G1	S0	281	45	36.9	52	40	21	280	235	40	SN5650-PMO-0180-05-E0-G1-S0-V04
5°	E0	G1	S1	281	45	36.9	52	40	21	280	235	40	SN5650-PMO-0180-05-E0-G1-S1-V04
5°	E1	G0	S0	281	45	36.9	52	40	21	280	235	40	SN5650-PMO-0180-05-E1-G0-S0-V04
5°	E1	G0	S1	281	45	36.9	52	40	21	280	235	40	SN5650-PMO-0180-05-E1-G0-S1-V04
5°	E1	G1	S0	281	45	36.9	52	40	21	280	235	40	SN5650-PMO-0180-05-E1-G1-S0-V04
5°	E1	G1	S1	281	45	36.9	52	40	21	280	235	40	SN5650-PMO-0180-05-E1-G1-S1-V04
10°	E0	G0	S0	287	42	39.2	52	41.6	22	285	240	15	SN5650-PMO-0180-10-E0-G0-S0-V04
10°	E0	G0	S1	287	42	39.2	52	41.6	22	285	240	15	SN5650-PMO-0180-10-E0-G0-S1-V04
10°	E0	G1	S0	287	42	39.2	52	41.6	22	285	240	15	SN5650-PMO-0180-10-E0-G1-S0-V04
10°	E0	G1	S1	287	42	39.2	52	41.6	22	285	240	15	SN5650-PMO-0180-10-E0-G1-S1-V04
10°	E1	G0	S0	287	42	39.2	52	41.6	22	285	240	15	SN5650-PMO-0180-10-E1-G0-S0-V04
10°	E1	G0	S1	287	42	39.2	52	41.6	22	285	240	15	SN5650-PMO-0180-10-E1-G0-S1-V04
10°	E1	G1	S0	287	42	39.2	52	41.6	22	285	240	15	SN5650-PMO-0180-10-E1-G1-S0-V04
10°	E1	G1	S1	287	42	39.2	52	41.6	22	285	240	15	SN5650-PMO-0180-10-E1-G1-S1-V04
15°	E0	G0	S0	292	40	41.2	52	44.1	22	285	240	15	SN5650-PMO-0180-15-E0-G0-S0-V04
15°	E0	G0	S1	292	40	41.2	52	44.1	22	285	240	15	SN5650-PMO-0180-15-E0-G0-S1-V04
15°	E0	G1	S0	292	40	41.2	52	44.1	22	285	240	15	SN5650-PMO-0180-15-E0-G1-S0-V04
15°	E0	G1	S1	292	40	41.2	52	44.1	22	285	240	15	SN5650-PMO-0180-15-E0-G1-S1-V04
15°	E1	G0	S0	292	40	41.2	52	44.1	22	285	240	15	SN5650-PMO-0180-15-E1-G0-S0-V04
15°	E1	G0	S1	292	40	41.2	52	44.1	22	285	240	15	SN5650-PMO-0180-15-E1-G0-S1-V04
15°	E1	G1	S0	292	40	41.2	52	44.1	22	285	240	15	SN5650-PMO-0180-15-E1-G1-S0-V04



W	E	G	SE	L	W1	s	S1	S2	Sz	L1	L2	L3	No.
15°	E1	G1	S1	292	40	41.2	52	44.1	22	285	240	15	SN5650-PMO-0180-15-E1-G1-S1-V04
20°	E0	G0	S0	295	37	44.2	52	46.4	27	295	195	25	SN5650-PMO-0180-20-E0-G0-S0-V04
20°	E0	G0	S1	295	37	44.2	52	46.4	27	295	195	25	SN5650-PMO-0180-20-E0-G0-S1-V04
20°	E0	G1	S0	295	37	44.2	52	46.4	27	295	195	25	SN5650-PMO-0180-20-E0-G1-S0-V04
20°	E0	G1	S1	295	37	44.2	52	46.4	27	295	195	25	SN5650-PMO-0180-20-E0-G1-S1-V04
20°	E1	G0	S0	295	37	44.2	52	46.4	27	295	195	25	SN5650-PMO-0180-20-E1-G0-S0-V04
20°	E1	G0	S1	295	37	44.2	52	46.4	27	295	195	25	SN5650-PMO-0180-20-E1-G0-S1-V04
20°	E1	G1	S0	295	37	44.2	52	46.4	27	295	195	25	SN5650-PMO-0180-20-E1-G1-S0-V04
20°	E1	G1	S1	295	37	44.2	52	46.4	27	295	195	25	SN5650-PMO-0180-20-E1-G1-S1-V04
25°	E0	G0	S0	295	35	47	52	49.7	32	295	195	25	SN5650-PMO-0180-25-E0-G0-S0-V04
25°	E0	G0	S1	295	35	47	52	49.7	32	295	195	25	SN5650-PMO-0180-25-E0-G0-S1-V04
25°	E0	G1	S0	295	35	47	52	49.7	32	295	195	25	SN5650-PMO-0180-25-E0-G1-S0-V04
25°	E0	G1	S1	295	35	47	52	49.7	32	295	195	25	SN5650-PMO-0180-25-E0-G1-S1-V04
25°	E1	G0	S0	295	35	47	52	49.7	32	295	195	25	SN5650-PMO-0180-25-E1-G0-S0-V04
25°	E1	G0	S1	295	35	47	52	49.7	32	295	195	25	SN5650-PMO-0180-25-E1-G0-S1-V04
25°	E1	G1	S0	295	35	47	52	49.7	32	295	195	25	SN5650-PMO-0180-25-E1-G1-S0-V04
25°	E1	G1	S1	295	35	47	52	49.7	32	295	195	25	SN5650-PMO-0180-25-E1-G1-S1-V04
30°	E0	G0	S0	310	32	50.9	52	53	37	310	170	30	SN5650-PMO-0180-30-E0-G0-S0-V04
30°	E0	G0	S1	310	32	50.9	52	53	37	310	170	30	SN5650-PMO-0180-30-E0-G0-S1-V04
30°	E0	G1	S0	310	32	50.9	52	53	37	310	170	30	SN5650-PMO-0180-30-E0-G1-S0-V04
30°	E0	G1	S1	310	32	50.9	52	53	37	310	170	30	SN5650-PMO-0180-30-E0-G1-S1-V04
30°	E1	G0	S0	310	32	50.9	52	53	37	310	170	30	SN5650-PMO-0180-30-E1-G0-S0-V04
30°	E1	G0	S1	310	32	50.9	52	53	37	310	170	30	SN5650-PMO-0180-30-E1-G0-S1-V04
30°	E1	G1	S0	310	32	50.9	52	53	37	310	170	30	SN5650-PMO-0180-30-E1-G1-S0-V04
30°	E1	G1	S1	310	32	50.9	52	53	37	310	170	30	SN5650-PMO-0180-30-E1-G1-S1-V04
35°	E0	G0	S0	310	30	49.7	47	52	37	310	170	30	SN5650-PMO-0180-35-E0-G0-S0-V04
35°	E0	G0	S1	310	30	49.7	47	52	37	310	170	30	SN5650-PMO-0180-35-E0-G0-S1-V04
35°	E0	G1	S0	310	30	49.7	47	52	37	310	170	30	SN5650-PMO-0180-35-E0-G1-S0-V04
35°	E0	G1	S1	310	30	49.7	47	52	37	310	170	30	SN5650-PMO-0180-35-E0-G1-S1-V04
35°	E1	G0	S0	310	30	49.7	47	52	37	310	170	30	SN5650-PMO-0180-35-E1-G0-S0-V04
35°	E1	G0	S1	310	30	49.7	47	52	37	310	170	30	SN5650-PMO-0180-35-E1-G0-S1-V04
35°	E1	G1	S0	310	30	49.7	47	52	37	310	170	30	SN5650-PMO-0180-35-E1-G1-S0-V04
35°	E1	G1	S1	310	30	49.7	47	52	37	310	170	30	SN5650-PMO-0180-35-E1-G1-S1-V04
40°	E0	G0	S0	315	27	54.7	47	56.5	37	315	162	15	SN5650-PMO-0180-40-E0-G0-S0-V04
40°	E0	G0	S1	315	27	54.7	47	56.5	37	315	162	15	SN5650-PMO-0180-40-E0-G0-S1-V04
40°	E0	G1	S0	315	27	54.7	47	56.5	37	315	162	15	SN5650-PMO-0180-40-E0-G1-S0-V04
40°	E0	G1	S1	315	27	54.7	47	56.5	37	315	162	15	SN5650-PMO-0180-40-E0-G1-S1-V04
40°	E1	G0	S0	315	27	54.7	47	56.5	37	315	162	15	SN5650-PMO-0180-40-E1-G0-S0-V04
40°	E1	G0	S1	315	27	54.7	47	56.5	37	315	162	15	SN5650-PMO-0180-40-E1-G0-S1-V04
40°	E1	G1	S0	315	27	54.7	47	56.5	37	315	162	15	SN5650-PMO-0180-40-E1-G1-S0-V04
40°	E1	G1	S1	315	27	54.7	47	56.5	37	315	162	15	SN5650-PMO-0180-40-E1-G1-S1-V04
45°	E0	G0	S0	315	25	60.2	47	62.5	42	315	162	15	SN5650-PMO-0180-45-E0-G0-S0-V04
45°	E0	G0	S1	315	25	60.2	47	62.5	42	315	162	15	SN5650-PMO-0180-45-E0-G0-S1-V04
45°	E0	G1	S0	315	25	60.2	47	62.5	42	315	162	15	SN5650-PMO-0180-45-E0-G1-S0-V04
45°	E0	G1	S1	315	25	60.2	47	62.5	42	315	162	15	SN5650-PMO-0180-45-E0-G1-S1-V04
45°	E1	G0	S0	315	25	60.2	47	62.5	42	315	162	15	SN5650-PMO-0180-45-E1-G0-S0-V04
45°	E1	G0	S1	315	25	60.2	47	62.5	42	315	162	15	SN5650-PMO-0180-45-E1-G0-S1-V04
45°	E1	G1	S0	315	25	60.2	47	62.5	42	315	162	15	SN5650-PMO-0180-45-E1-G1-S0-V04
45°	E1	G1	S1	315	25	60.2	47	62.5	42	315	162	15	SN5650-PMO-0180-45-E1-G1-S1-V04
50°	E0	G0	S0	320	22	67.8	47	59.5	47	320	147	5	SN5650-PMO-0180-50-E0-G0-S0-V04
50°	E0	G0	S1	320	22	67.8	47	59.5	47	320	147	5	SN5650-PMO-0180-50-E0-G0-S1-V04
50°	E0	G1	S0	320	22	67.8	47	59.5	47	320	147	5	SN5650-PMO-0180-50-E0-G1-S0-V04
50°	E0	G1	S1	320	22	67.8	47	59.5	47	320	147	5	SN5650-PMO-0180-50-E0-G1-S1-V04
50°	E1	G0	S0	320	22	67.8	47	59.5	47	320	147	5	SN5650-PMO-0180-50-E1-G0-S0-V04
50°	E1	G0	S1	320	22	67.8	47	59.5	47	320	147	5	SN5650-PMO-0180-50-E1-G0-S1-V04



W	E	G	SE	L	W1	s	S1	S2	Sz	L1	L2	L3	No.
50°	E1	G1	S0	320	22	67.8	47	59.5	47	320	147	5	SN5650-PMO-0180-50-E1-G1-S0-V04
50°	E1	G1	S1	320	22	67.8	47	59.5	47	320	147	5	SN5650-PMO-0180-50-E1-G1-S1-V04
55°	E0	G0	S0	320	20	68.8	42	70.7	47	320	147	5	SN5650-PMO-0180-55-E0-G0-S0-V04
55°	E0	G0	S1	320	20	68.8	42	70.7	47	320	147	5	SN5650-PMO-0180-55-E0-G0-S1-V04
55°	E0	G1	S0	320	20	68.8	42	70.7	47	320	147	5	SN5650-PMO-0180-55-E0-G1-S0-V04
55°	E0	G1	S1	320	20	68.8	42	70.7	47	320	147	5	SN5650-PMO-0180-55-E0-G1-S1-V04
55°	E1	G0	S0	320	20	68.8	42	70.7	47	320	147	5	SN5650-PMO-0180-55-E1-G0-S0-V04
55°	E1	G0	S1	320	20	68.8	42	70.7	47	320	147	5	SN5650-PMO-0180-55-E1-G0-S1-V04
55°	E1	G1	S0	320	20	68.8	42	70.7	47	320	147	5	SN5650-PMO-0180-55-E1-G1-S0-V04
55°	E1	G1	S1	320	20	68.8	42	70.7	47	320	147	5	SN5650-PMO-0180-55-E1-G1-S1-V04
60°	E0	G0	S0	325	17	70.8	37	72.1	24	325	127	5	SN5650-PMO-0180-60-E0-G0-S0-V04
60°	E0	G0	S1	325	17	70.8	37	72.1	24	325	127	5	SN5650-PMO-0180-60-E0-G0-S1-V04
60°	E0	G1	S0	325	17	70.8	37	72.1	24	325	127	5	SN5650-PMO-0180-60-E0-G1-S0-V04
60°	E0	G1	S1	325	17	70.8	37	72.1	24	325	127	5	SN5650-PMO-0180-60-E0-G1-S1-V04
60°	E1	G0	S0	325	17	70.8	37	72.1	24	325	127	5	SN5650-PMO-0180-60-E1-G0-S0-V04
60°	E1	G0	S1	325	17	70.8	37	72.1	24	325	127	5	SN5650-PMO-0180-60-E1-G0-S1-V04
60°	E1	G1	S0	325	17	70.8	37	72.1	24	325	127	5	SN5650-PMO-0180-60-E1-G1-S0-V04
60°	E1	G1	S1	325	17	70.8	37	72.1	24	325	127	5	SN5650-PMO-0180-60-E1-G1-S1-V04
65°	E0	G0	S0	325	15	73.1	32	74.6	24	325	127	5	SN5650-PMO-0180-65-E0-G0-S0-V04
65°	E0	G0	S1	325	15	73.1	32	74.6	24	325	127	5	SN5650-PMO-0180-65-E0-G0-S1-V04
65°	E0	G1	S0	325	15	73.1	32	74.6	24	325	127	5	SN5650-PMO-0180-65-E0-G1-S0-V04
65°	E0	G1	S1	325	15	73.1	32	74.6	24	325	127	5	SN5650-PMO-0180-65-E0-G1-S1-V04
65°	E1	G0	S0	325	15	73.1	32	74.6	24	325	127	5	SN5650-PMO-0180-65-E1-G0-S0-V04
65°	E1	G0	S1	325	15	73.1	32	74.6	24	325	127	5	SN5650-PMO-0180-65-E1-G0-S1-V04
65°	E1	G1	S0	325	15	73.1	32	74.6	24	325	127	5	SN5650-PMO-0180-65-E1-G1-S0-V04
65°	E1	G1	S1	325	15	73.1	32	74.6	24	325	127	5	SN5650-PMO-0180-65-E1-G1-S1-V04
70°	E0	G0	S0	340	12	77.2	27	78.2	52	330	113	10	SN5650-PMO-0180-70-E0-G0-S0-V04
70°	E0	G0	S1	340	12	77.2	27	78.2	52	330	113	10	SN5650-PMO-0180-70-E0-G0-S1-V04
70°	E0	G1	S0	340	12	77.2	27	78.2	52	330	113	10	SN5650-PMO-0180-70-E0-G1-S0-V04
70°	E0	G1	S1	340	12	77.2	27	78.2	52	330	113	10	SN5650-PMO-0180-70-E0-G1-S1-V04
70°	E1	G0	S0	340	12	77.2	27	78.2	52	330	113	10	SN5650-PMO-0180-70-E1-G0-S0-V04
70°	E1	G0	S1	340	12	77.2	27	78.2	52	330	113	10	SN5650-PMO-0180-70-E1-G0-S1-V04
70°	E1	G1	S0	340	12	77.2	27	78.2	52	330	113	10	SN5650-PMO-0180-70-E1-G1-S0-V04
70°	E1	G1	S1	340	12	77.2	27	78.2	52	330	113	10	SN5650-PMO-0180-70-E1-G1-S1-V04
75°	E0	G0	S0	340	10	83.7	22	84.7	48	330	113	10	SN5650-PMO-0180-75-E0-G0-S0-V04
75°	E0	G0	S1	340	10	83.7	22	84.7	48	330	113	10	SN5650-PMO-0180-75-E0-G0-S1-V04
75°	E0	G1	S0	340	10	83.7	22	84.7	48	330	113	10	SN5650-PMO-0180-75-E0-G1-S0-V04
75°	E0	G1	S1	340	10	83.7	22	84.7	48	330	113	10	SN5650-PMO-0180-75-E0-G1-S1-V04
75°	E1	G0	S0	340	10	83.7	22	84.7	48	330	113	10	SN5650-PMO-0180-75-E1-G0-S0-V04
75°	E1	G0	S1	340	10	83.7	22	84.7	48	330	113	10	SN5650-PMO-0180-75-E1-G0-S1-V04
75°	E1	G1	S0	340	10	83.7	22	84.7	48	330	113	10	SN5650-PMO-0180-75-E1-G1-S0-V04
75°	E1	G1	S1	340	10	83.7	22	84.7	48	330	113	10	SN5650-PMO-0180-75-E1-G1-S1-V04

SN5650-PMO-0180-

Bauteile Components

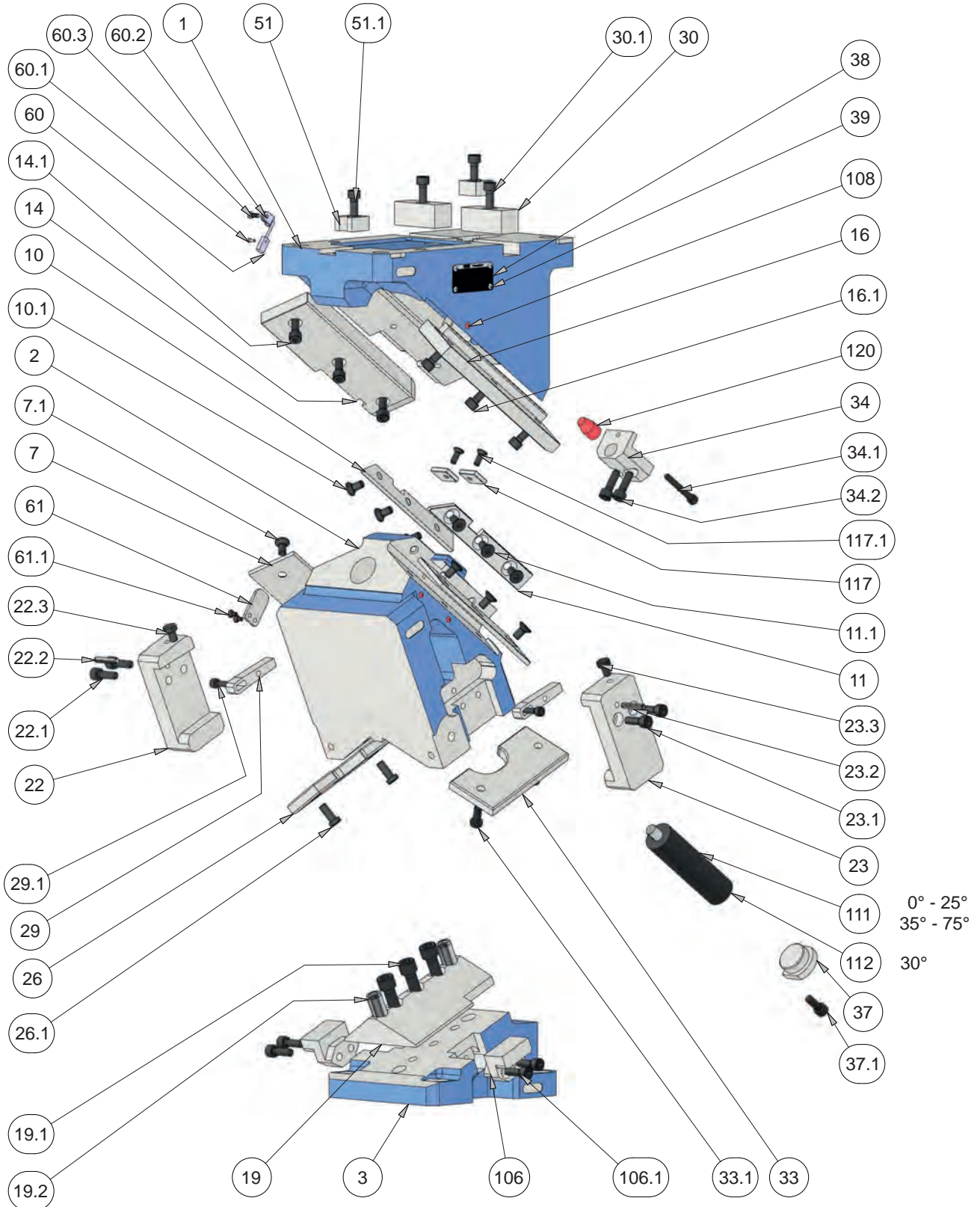

Ersatzteilstückliste je Schieber unter www.strack.de

Sparepart lists under www.strack.de

SN5650-PMO-0180-

Kraftverteilung

Force Distribution

W	FS [kN]	FP [kN]	Fh1 [kN]	FW [kN]	Fh2 [kN]	h1 [mm]	h2 [mm]	FA [kN]
00°	411	386	411	386	0	160	40	41
05°	435	193	206	371	31	150	50	46
10°	459	435	389	356	63	140	60	51
15°	474	218	195	328	86	133	68	52
20°	489	468	350	301	109	125	75	54
25°	507	234	175	272	125	120	75	54
30°	525	506	314	243	140	115	75	55
35°	548	253	157	215	149	108	76	54
40°	571	554	281	187	157	100	76	53
45°	581	277	140	156	152	88	88	52
50°	590	576	231	124	148	75	99	53
55°	607	288	116	98	137	73	112	53
60°	623	612	186	73	126	70	125	53
65°	629	617	164	47	102	70	120	53
70°	651	309	82	31	80	65	128	53
75°	673	666	116	16	58	60	135	52

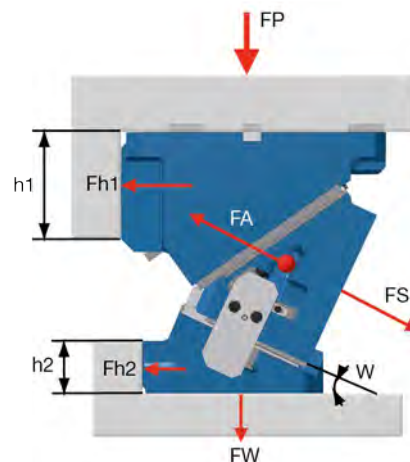

W = Schieberwinkel
FP = P-Press
FW = W-Werkzeug
FS = S-Schieberkraft
FA = A-Abstreifkraft
Fh1 = h1-Abschulterung oben
Fh2 = h2-Abschulterung unten

W = Cam Angle
FP = P-Press
FW = W-Tool
FS = S-Cam Force
FA = A-Retractility
Fh1 = h1-Shouldering above
Fh2 = h2-Shouldering below

SN5650-PMO-0180-

Schieberkräfte

Cam Force

Abschulterung

Shouldering

Passfeder

Fitting Key

SN5650-PMO-0180-0°

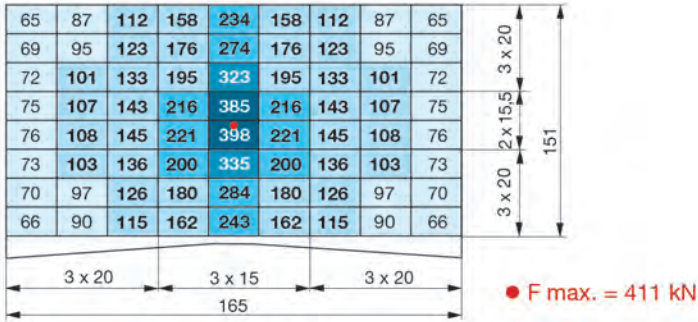

53	53	61	66	72	66	61	53	53
53	61	66	72	78	72	66	61	53
53	61	66	72	78	72	66	61	53
53	61	66	72	78	72	66	61	53
53	61	66	72	78	72	66	61	53
53	61	66	72	78	72	66	61	53
53	61	66	72	78	72	66	61	53
53	61	66	72	78	72	66	61	53

SN5650-PMO-0180-10°

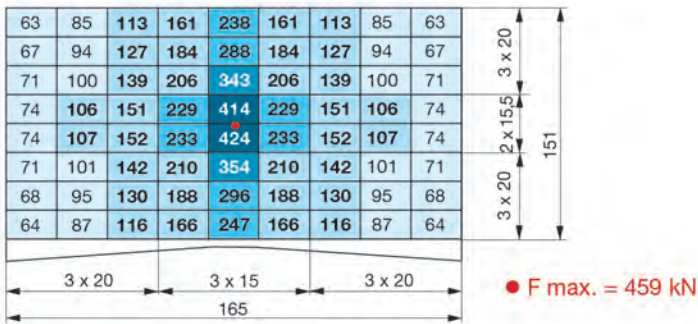

59	59	69	78	85	78	69	59	59
59	69	78	85	92	85	78	69	59
59	69	78	85	92	85	78	69	59
59	69	78	85	92	85	78	69	59
59	69	78	85	92	85	78	69	59
59	69	78	85	92	85	78	69	59
59	69	78	85	92	85	78	69	59
59	69	78	85	92	85	78	69	59

SN5650-PMO-0180-20°

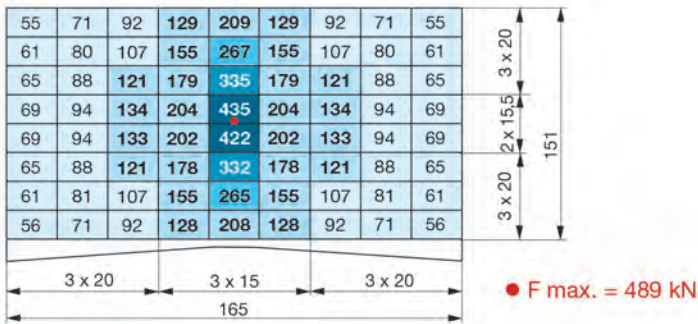

55	55	71	87	98	87	71	55	55
61	75	87	97	109	97	87	75	61
64	75	87	97	109	97	87	75	64
64	75	87	97	109	97	87	75	64
64	75	87	97	109	97	87	75	64
64	75	87	97	109	97	87	75	64
61	75	87	97	109	97	87	75	61
56	71	87	98	109	98	87	71	56

SN5650-PMO-0180-30°

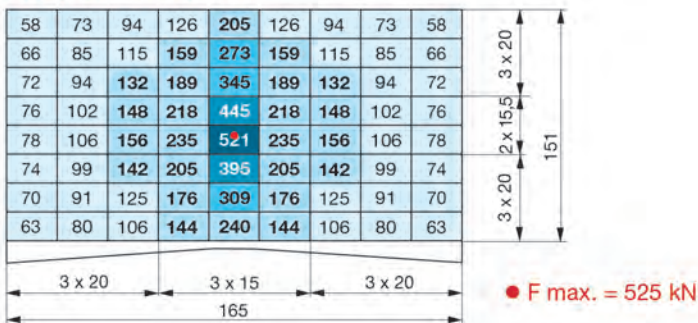

58	58	73	94	117	94	73	58	58
66	85	103	116	131	116	103	85	66
72	87	103	116	131	116	103	87	72
74	87	103	116	131	116	103	87	74
74	87	103	116	131	116	103	87	74
74	87	103	116	131	116	103	87	74
70	87	103	116	131	116	103	87	70
63	80	103	117	131	117	103	80	63

SN5650-PMO-0180-

Schieberkräfte

Cam Force

Abschulterung

Shouldering

Passfeder

Fitting Key

SN5650-PMO-0180-40°

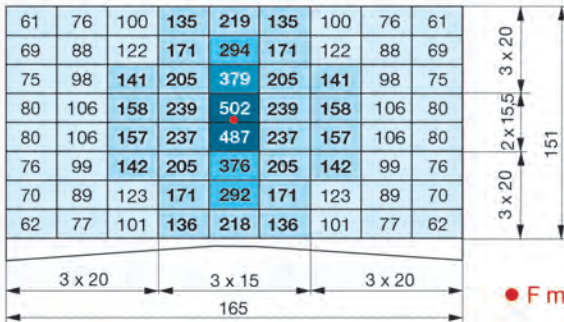

61	61	76	100	135	100	76	61	61
69	88	122	142	160	142	122	88	69
75	98	122	141	160	141	122	98	75
80	101	122	141	160	141	122	101	80
80	101	122	141	160	141	122	101	80
76	99	122	141	160	141	122	99	76
70	89	122	142	160	142	122	89	70
62	77	101	136	160	136	101	77	62

SN5650-PMO-0180-50°

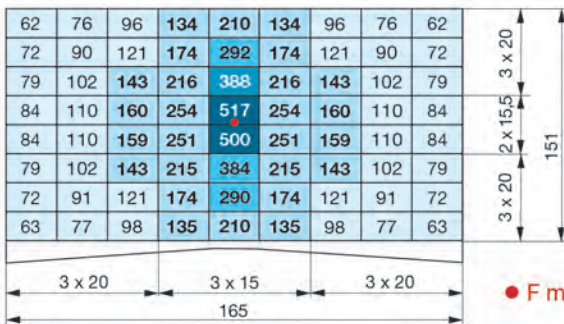

62	62	76	96	134	96	76	62	62
72	90	121	174	202	174	121	90	72
79	102	143	177	202	177	143	102	79
84	110	147	177	202	177	147	110	84
84	110	147	177	202	177	147	110	84
79	102	143	177	202	177	143	102	79
72	91	121	174	202	174	121	91	72
63	77	98	135	202	135	98	77	63

SN5650-PMO-0180-60°

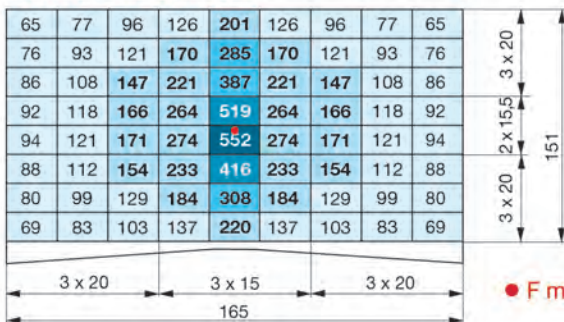

65	65	77	96	126	96	77	65	65
76	93	121	170	265	170	121	93	76
86	108	147	221	265	221	147	108	86
92	118	166	233	265	233	166	118	92
94	121	171	233	265	233	171	121	94
88	112	154	233	265	233	154	112	88
80	99	129	184	265	184	129	99	80
69	83	103	137	220	137	103	83	69

SN5650-PMO-0180-70°

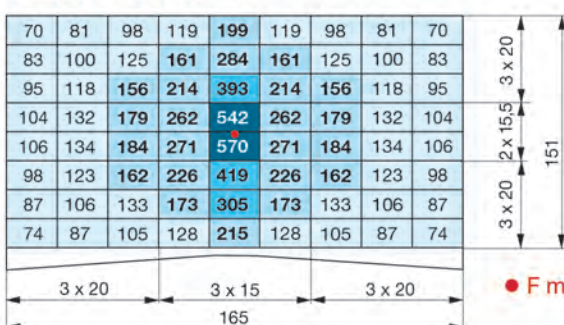

70	70	81	98	119	98	81	70	70
83	100	125	161	284	161	125	100	83
95	118	156	214	353	214	156	118	95
104	132	179	262	381	262	179	132	104
106	134	184	269	381	269	184	134	106
98	123	162	226	364	226	162	123	98
87	106	133	173	305	173	133	106	87
74	87	105	128	215	128	105	87	74