

Kegeldistanzen VW-Norm 39V 1168

Locating cone VW-norm 39V 1168

Cônes de distance Norme de VW 39V 1168



Stanzerei Großwerkzeugbau
Punching shop
large tool making
Atelier d'emboutissage
construction de gros outils

SN43-

Mat.: ST



SN43-Type-D

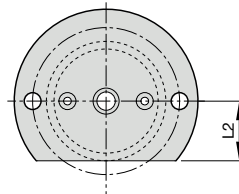
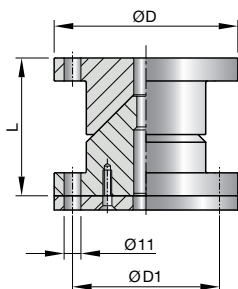

Type 2

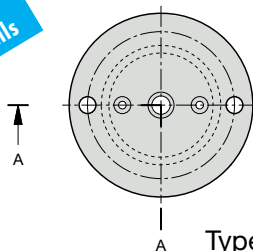

Type 1

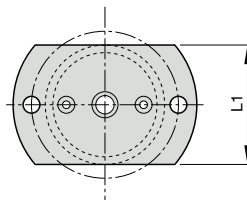

Type 3

Type	D	L	D1	L1	L2
1	100	80	76	-	-
	120	90	96	-	-
2	100	80	76	-	29
	120	90	96	-	39
3	100	80	76	58	-
	120	90	96	78	-

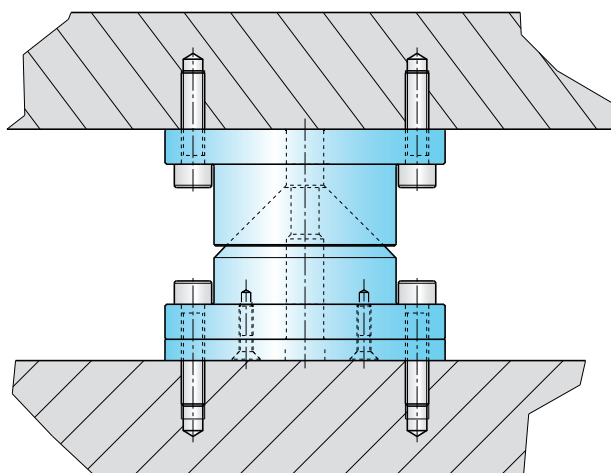

Distanzplatten
VW-Norm 39V 1168

Spacer plates
VW-norm 39V 1168

Plaques d'écartement
Norme de VW 39V 1168



Stanzerei Großwerkzeugbau
Punching shop
large tool making
Atelier d'emboutissage
construction de gros outils

SN43-DP-

Mat.: ST



SN43-DP-Type-D

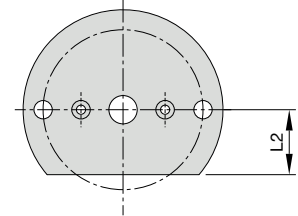
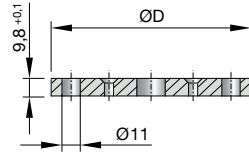

Type 2

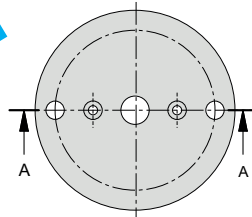

Type 1

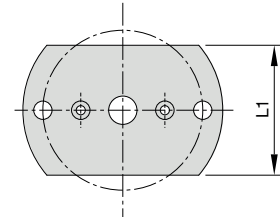

Type 3

Type	D	L1	L2
1	100	-	-
	120	-	-
2	100	-	29
	120	-	39
3	100	58	-
	120	78	-

