

Seitenschiebereinheiten mit Nockensystem

Lateral slide units with cam system

Unités de coulisseau latérales avec came système

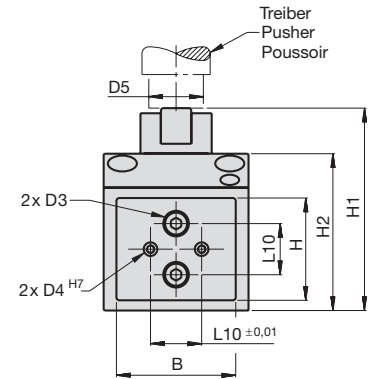
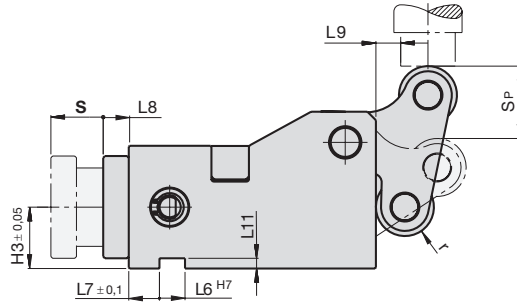

SN5610-

SN5610-Type-S

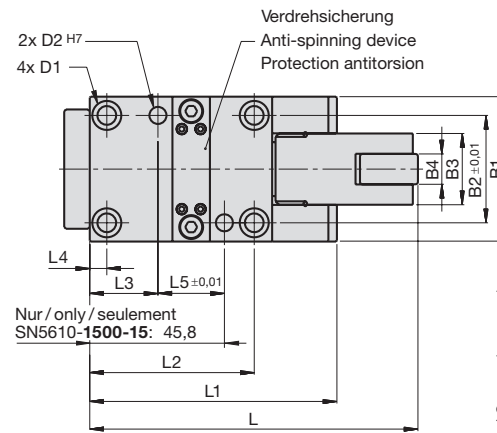

S = Hub / Stroke / Course

Maximale Neigung
Maximum inclination
Inclinaison maximale

SN5610- 3500-25
SN5610- 1500-15
SN5610- 5000-38
SN5610- 7000-50
SN5610-10000-63

max. 25°
max. 20°

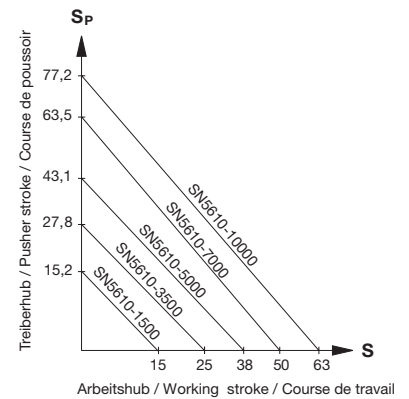
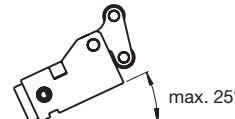
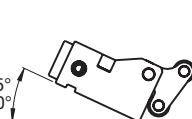

Type	L	L1	L2	L3	L4	L5	L6	L7	L8	L9	L10	L11	B	B1	B2	B3	B4	D1	D2	D3	D4	D5	H	H1	H2	H3	r
1500	116	90	58	-	5,25	-	12	14	15	6	26	4	45	65	53	28	14	M6	6	M6	6	25	45	76,7	67	27	10,5
3500	156,5	119	78,5	39	10	-	12	19	15	13	26	4	60	78	58	36	18	M10	10	M8	8	30	50	93	79	30	15
5000	190,5	145	96,5	40	10	39	15	18	15	20	30	6	70	85	63	42	18	M10	10	M8	8	35	60	120	92	36	17
7000	239	183	120	50	12	48	20	21	18	20	40	7	80	100	76	52	23	M12	12	M10	10	40	70	140	106,5	43	20
10000	283	221	145	58	13	66	25	23	20	20	47	8	90	110	84	60	24	M12	12	M12	10	45	80	165	127	50	24

Type	S	Sp	Max. Arbeitskraft Max. punching force Force de poinçonnage max.	daN	daN	Gasdruckfeder Gas spring Ressort à gaz
1500	15	15,2	1500 daN	170 (±10)	255	SN2808-V-170-50-4
3500	25	27,8	3500 daN	200 (±20)	290	SN2809-200-25-4
5000	38	43,1	5000 daN	200 (±20)	290	SN2809-200-38-4
7000	50	63,5	7000 daN	400 (±20)	635	SN2809-200-50-4
10000	63	77,2	10000 daN	600 (±20)	940	SN2809-600-63