

### Schieberhaltevorrichtungen

### Slide holding devices

### Verrous de tiroirs

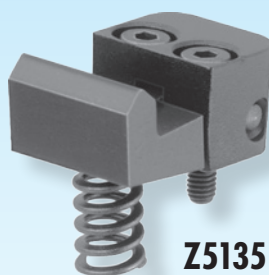

**Z5135**

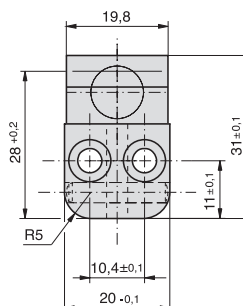
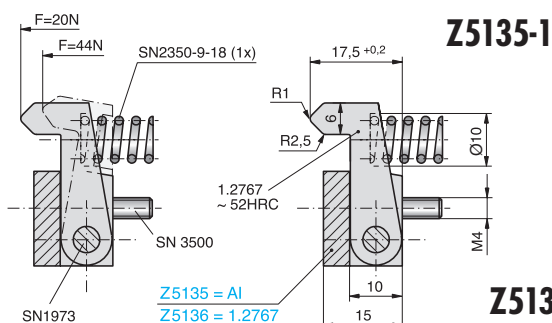

**Z5136-1**

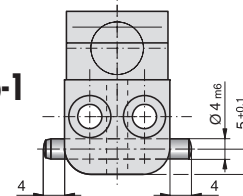

**Type 1**

5

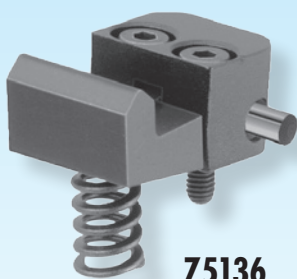

**Z5136**

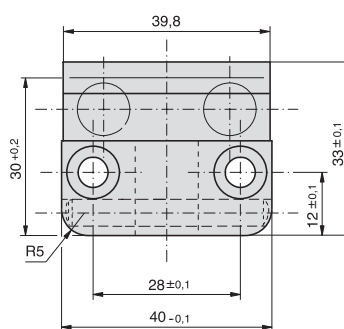
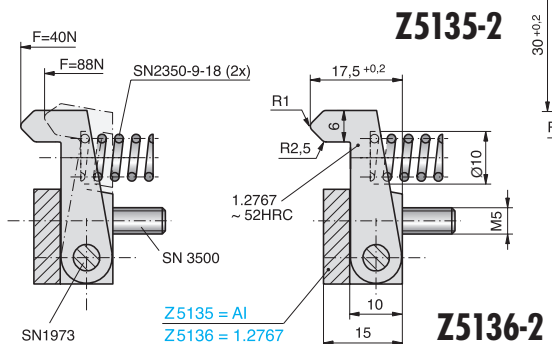

**Z5136-2**

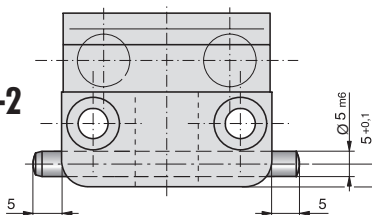

**Type 2**

**Z5135-**

Mat.: 1.2767/Al  
max. 100 °C



Z5135-Type



**Z5136-**

Mat.: 1.2767  
max. 100 °C



Z5136-Type



**Type**

**SN3450-**

**SN1973-**

1

M4-16

4-18

2

M5-16

5-36

**Type**

**SN3450-**

**SN1973-**

1

M4-16

4-28

2

M5-16

5-50

